



NAN HUA PRIMARY SCHOOL  
PRELIMINARY EXAMINATION 2023  
PRIMARY FIVE

SCIENCE  
(BOOKLET A)

**Total Time for Booklets A and B: 1 hour 45 minutes**

**INSTRUCTIONS TO CANDIDATES**

1. Write your name, index number and class in the spaces provided below.
2. Do not turn over the page until you are told to do so.
3. Follow all instructions carefully.
4. Answer all questions.
5. Use a 2B pencil to shade your answers on the Optical Answer Sheet (OAS).

**Marks Obtained**

Booklet A		/ 56
Booklet B		/ 44
Total		/ 100

Name: \_\_\_\_\_ ( )

Form Class: P5 \_\_\_\_\_

Teaching Group: 5S \_\_\_\_\_

Date: 24 October 2023

Parent's Signature: \_\_\_\_\_

This booklet consists of 19 printed pages and 1 blank page.



For each question from 1 to 28, four options are given. One of them is the correct answer. Make your choice (1, 2, 3 or 4) and shade your answer on the Optical Answer Sheet.  
(56 marks)

---

- 1 The diagram below shows the germination of a seed over time.

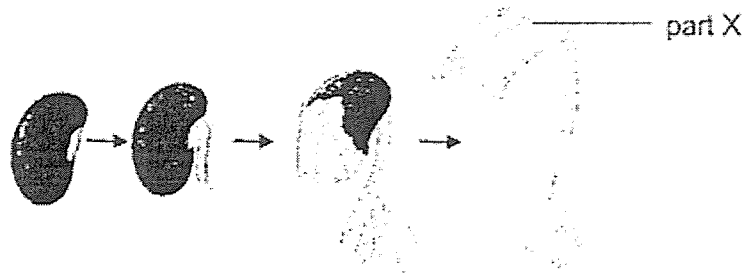

What is/are the function(s) of part X?

- A protects the seedling
  - B makes food for the adult plant
  - C absorbs water and minerals for the seedling
  - D provides food for the seedling before its leaves develop
- (1) A only
- (2) D only
- (3) A and C only
- (4) B and D only

- 2 The diagram shows how water and substance F are transported through different parts of a plant, X, Y, Z and P.

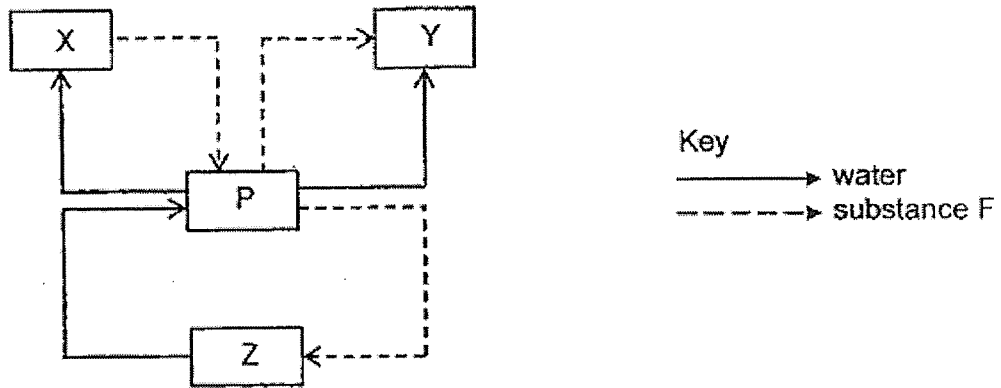

What do X, Y and Z represent?

	X	Y	Z
(1)	flower	stem	root
(2)	leaf	flower	root
(3)	leaf	root	flower
(4)	root	leaf	flower

- 3 Which two organ systems enable our body to receive nutrients from the food we eat and the water we drink?

- A Skeletal system
- B Digestive system
- C Circulatory system
- D Reproductive system

- (1) A and D only
- (2) B and C only
- (3) A and C only
- (4) B and D only

(Go on to the next page)

- 4 The diagram shows the human digestive system. S and T are parts of the digestive system.

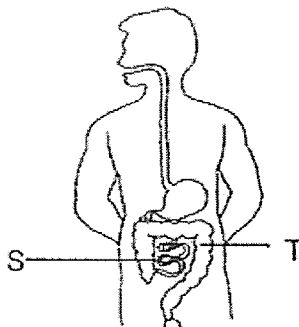

The table below shows statements describing what happens at parts S and T.

	S	T
A	Digestion takes place.	Digested food is absorbed.
B	It passes digested food to T for further digestion.	Undigested food from S is absorbed into the bloodstream.
C	Food is completely digested here.	Water is absorbed from undigested food.

Which of the following statements about parts S and T is/are correct?

- (1) A only
  - (2) C only
  - (3) A and B only
  - (4) B and C only
- 5 The diagram below shows the flow of blood in the human circulatory system.

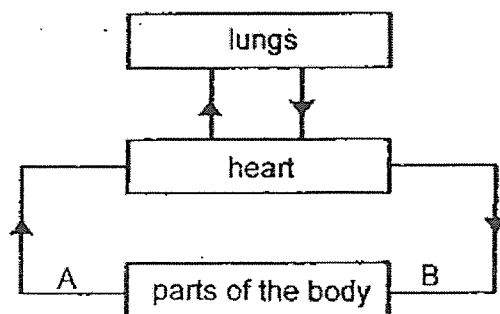

Which one of the following shows the correct amount of oxygen and carbon dioxide in the blood at A and B?

	Blood at A	Blood at B
(1)	low in carbon dioxide	low in oxygen
(2)	low in carbon dioxide	high in oxygen
(3)	high in carbon dioxide	low in oxygen
(4)	high in carbon dioxide	high in oxygen

6 The diagrams below show the parts of the fish and human respiratory system.

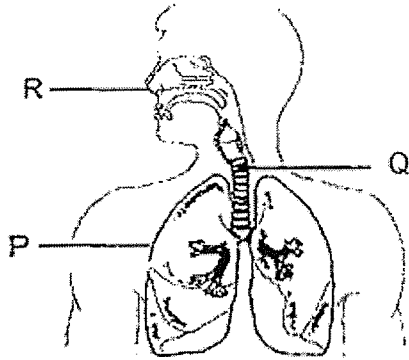

Human Respiratory System

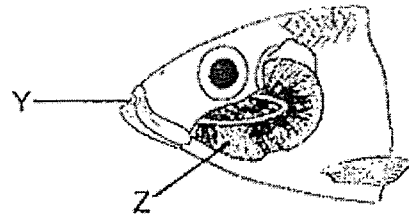

Fish Respiratory System

Which of the following correctly matches parts of the human and fish respiratory systems to perform similar functions?

	Fish	Human
(1)	Y	P
(2)	Y	Q
(3)	Z	R
(4)	Z	P

7 The diagram below shows the composition of air in the lift. Some adults and children were trapped in a faulty lift where air could not enter or escape.

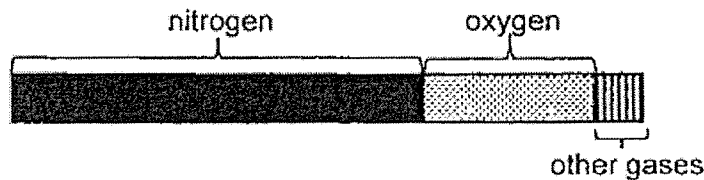

Which of the following best represents the composition of air after an hour?

- (1)
- (2)
- (3)
- (4)

(Go on to the next page)

- 8 William observed an animal cell and a plant cell under a microscope. The diagrams below show what he observed.

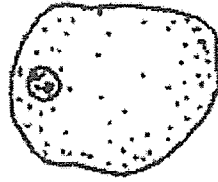

animal cell

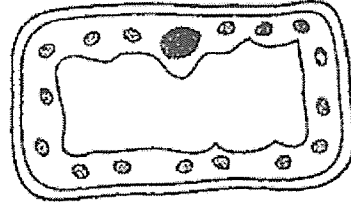

plant cell

Based on William's observations, which of the following conclusions is true?

- (1) The animal cell can make its own food.
- (2) Both cells contain genetic information.
- (3) Oxygen cannot move in and out of the plant cell.
- (4) The animal cell cannot carry out any cell activities.

- 9 Mr Tan carried out an experiment by placing two different cells, M and N, in water. The diagrams below show the observations made by Mr Tan at the beginning and at the end of the experiment.

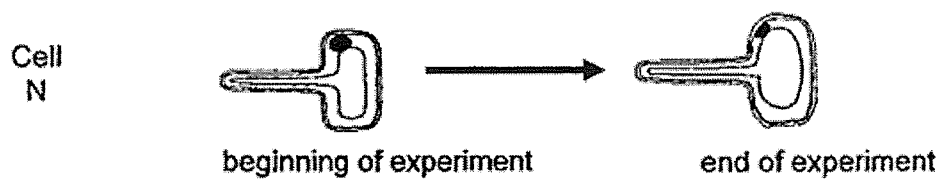
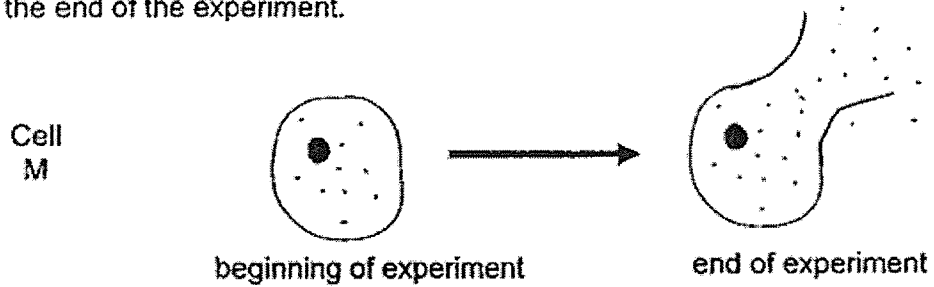

At the end of the experiment, Mr Tan observed that cell M had burst and cell N swelled.

Which of the following conclusions are correct?

- A Only cell M has a cell membrane.
- B Cell N has a cell wall to maintain its regular shape.
- C The cell membrane of cell N allowed water to enter.
- D Cell M has no cell wall. It bursts when water entered the cell.

- (1) A and B only
- (2) C and D only
- (3) A, B and D only
- (4) B, C and D only

(Go on to the next page)



- 10 The diagram below shows the life cycle of a mosquito.

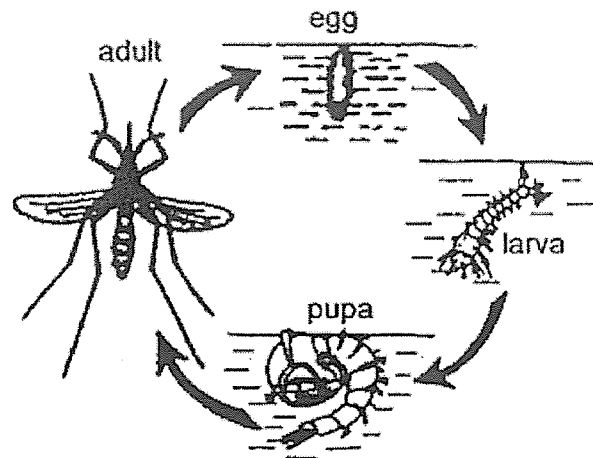

Which of the following statements on the life cycle of the mosquito is true?

- (1) The adult mosquito lives on land and in water.
  - (2) The mosquito has four stages in its life cycle.
  - (3) The young of the mosquito resembles its adult.
  - (4) Only one stage of the life cycle of the mosquito is spent in water.
- 11 Which of the following shows the correct life cycle of flowering plants?

(1)

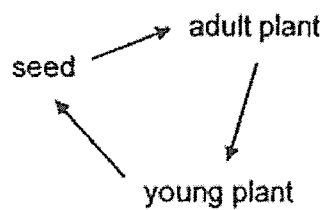

(2)

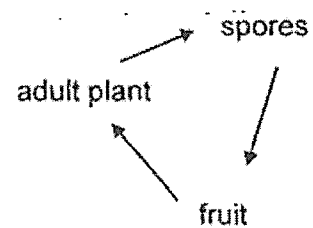

(3)

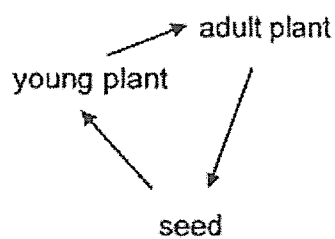

(4)

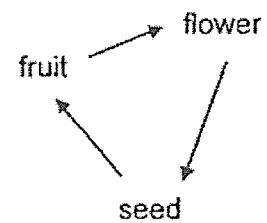

- 12 The diagram below shows the order of the processes involved in the reproduction of a flowering plant.



Which of the following correctly identifies processes P, Q and R ?

	P	Q	R
(1)	Fertilisation	Germination	Seed Dispersal
(2)	Germination	Fertilisation	Seed Dispersal
(3)	Fertilisation	Seed Dispersal	Germination
(4)	Seed Dispersal	Germination	Fertilisation

- 13 Mrs Lim wanted to create a new plant which has flowers with white and yellow petals. She used two parent plants of the same kind. The flowers of these plants have both male and female reproductive parts.

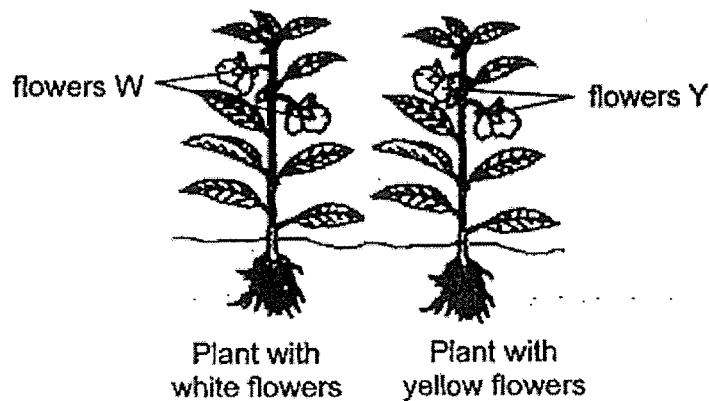

In order to create the new plant, Mrs Lim can \_\_\_\_\_.

- A remove all the ovaries and all the anthers of flowers W
- B remove all the ovaries of flowers W and all the stigmas of flowers Y
- C transfer the pollen grains from the anther of flower W to the stigma of flower Y
- D transfer the pollen grains from the anther of flower Y to the stigma of flower W

- (1) A and B only
- (2) C and D only
- (3) B, C and D only
- (4) A, B, C and D

(Go on to the next page)

- 14 The diagrams below show the parts of the plant reproductive system and the human male reproductive system.

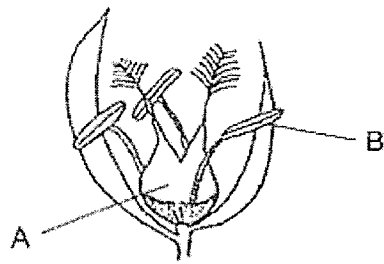

parts of plant reproductive system

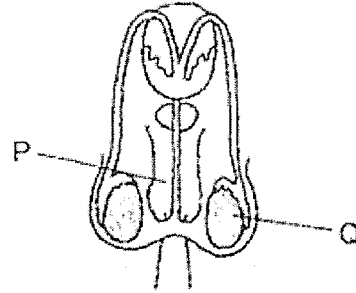

parts of human male reproductive system

Which of the following part of the reproductive systems correctly matches the function as stated below?

	Plant part that produces female sex cells	Human part that produces male sex cells
(1)	A	P
(2)	A	Q
(3)	B	P
(4)	B	Q

- 15 Study the classification chart below.

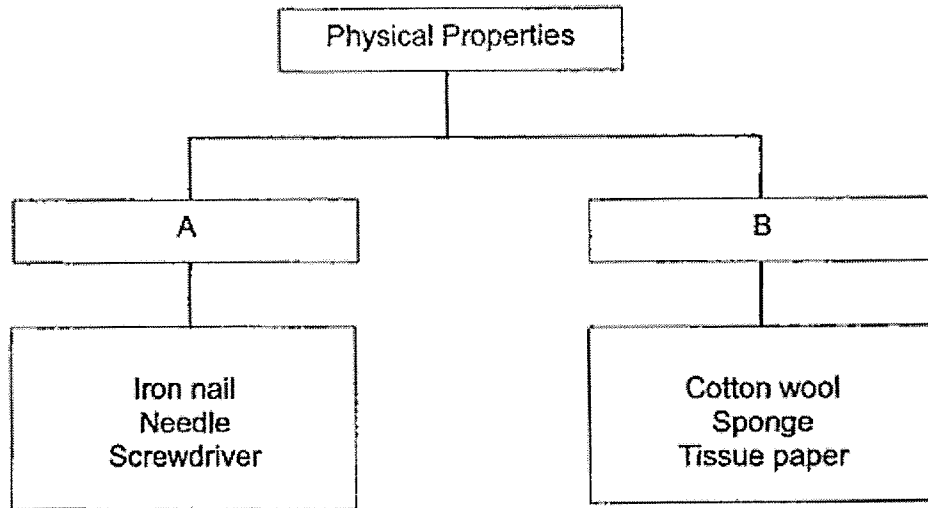

Which of the following properties could A and B be?

	A	B
(1)	Strong	Weak
(2)	Flexible	Stiff
(3)	Absorb water	Does not absorb water
(4)	Float on water	Sink in water

(Go on to the next page)

- 16 Alice wanted to choose a suitable material to make a classroom projector screen.

The properties of materials, W, X, Y, and Z are shown in the table below.

Properties	Materials			
	W	X	Y	Z
Strong	✓	✓	✓	x
Flexible	x	✓	✓	x
Allows light to pass through	✓	x	✓	✓

Key  
 ✓ : yes  
 x : no

Which of the following material should she choose?

- (1) Material W
  - (2) Material X
  - (3) Material Y
  - (4) Material Z
- 17 The properties of three objects are shown in the table below.

Properties	Objects		
	rubber band	fish tank	cotton towel
S	Yes	No	Yes
transparent	No	Yes	No

Which of the following best represent property S?

- (1) strong
- (2) flexible
- (3) waterproof
- (4) able to conduct electricity

18 A freely suspended magnet will always point in the \_\_\_\_\_ direction.

- (1) East-West
- (2) South-East
- (3) West-North
- (4) North-South

19 Alex carried out an experiment using bar Q and a magnet. One end of bar Q was marked 'X'. When placed near the magnet, bar Q was pulled towards the magnet in all two set-ups, A and B, as shown below.

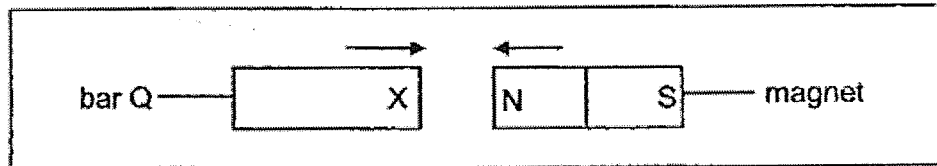

Set-up A

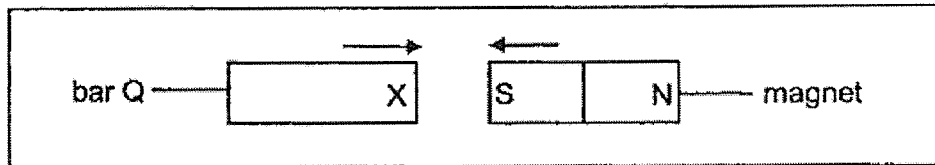

Set-up B

What conclusion can be drawn from the above experiment?

- (1) Bar Q is a magnet.
- (2) X is the South pole of bar Q.
- (3) X is the North pole of bar Q.
- (4) Bar Q is made of a magnetic material.

(Go on to the next page)

- 20 The diagram below shows a container containing two substances, X and Y.

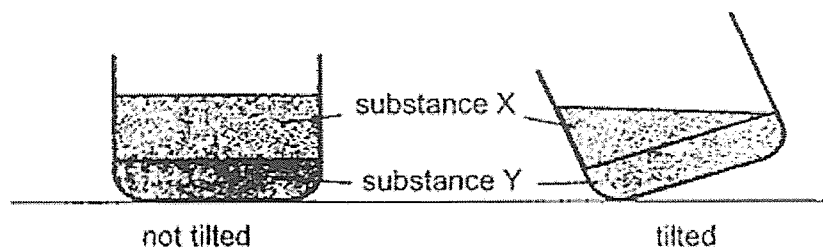

Based on your observation, which of the following correctly represents that state of matter of substances X and Y?

	X	Y
(1)	solid	solid
(2)	solid	liquid
(3)	liquid	liquid
(4)	liquid	solid

- 21 Study the following diagrams carefully.

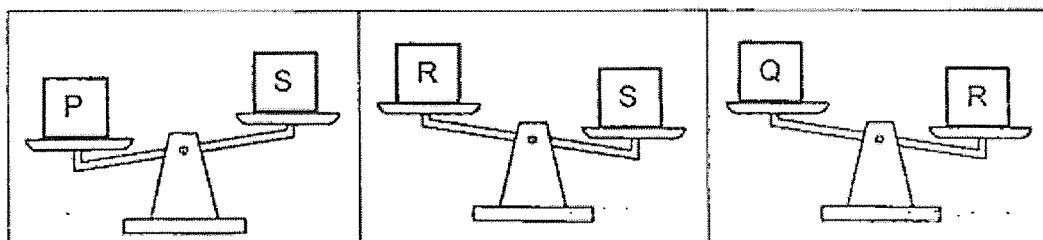

Which of the following correctly arranges the masses of objects P, Q, R and S from the smallest to the largest?

- (1) P, S, R, Q
- (2) Q, R, S, P
- (3) R, S, Q, P
- (4) S, R, P, Q

- 22 Mingyi cannot open the lid of a glass bottle.



What can he do so that the lid can be loosened easily?

- (1) Place the bottle in the refrigerator for ten minutes.
  - (2) Cover the lid of the bottle with a piece of cold towel.
  - (3) Cover the lid of the bottle with a piece of warm towel.
  - (4) Put some ice cubes on the lid of the bottle and place the bottom of the bottle in a basin of hot water.
- 23 A test-tube containing some water at  $10^{\circ}\text{C}$  was placed in a beaker containing 100 ml of oil at  $70^{\circ}\text{C}$ . The set-up was left in the room for some time.

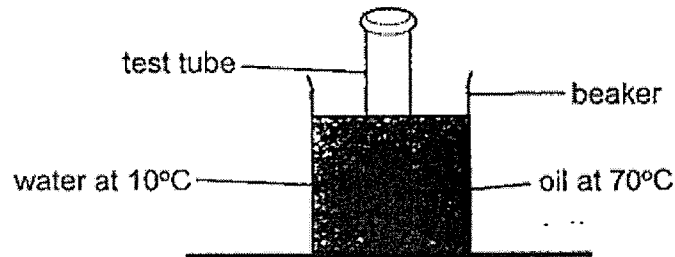

Three students made the following statements.

- |       |   |
|-------|---|
| Andy  | Heat is transferred from the oil to the water.  |
| Bobby | The temperature of the water increased after some time as it gains heat from the oil.                   |
| Catty | The temperature of the oil decreased after some time as it lost heat to the water and the surroundings. |

Who made the correct statement(s)?

- (1) Andy only
- (2) Andy and Catty only
- (3) Bobby and Catty only
- (4) Andy, Bobby and Catty

(Go on to the next page)



24 Which of the following is a source of light?

(1)



moon

(2)



mirror

(3)

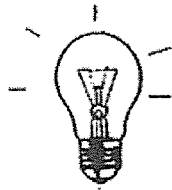

a lighted bulb

(4)



ring

25 The pictures below show the back of Andy's hands.

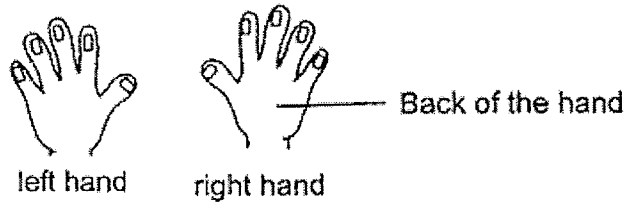

Andy placed one of his hands between a projector and a screen, at either position Y or Z, with his palm facing the screen. A shadow was formed on the screen. The shadow is about the same size as Andy's hand.

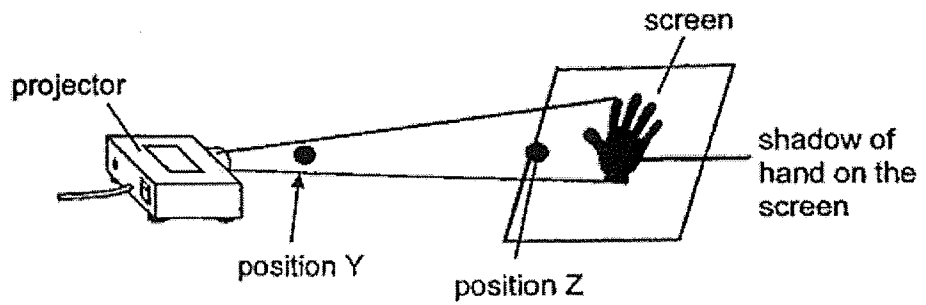

Which hand did Andy use and in which position was it placed?

	Which hand was used?	Where was the hand placed?
(1)	Left hand	Position Y
(2)	Left hand	Position Z
(3)	Right hand	Position Y
(4)	Right hand	Position Z

(Go on to the next page)

- 26 The diagram below shows the arrangements of four bulbs in a circuit.

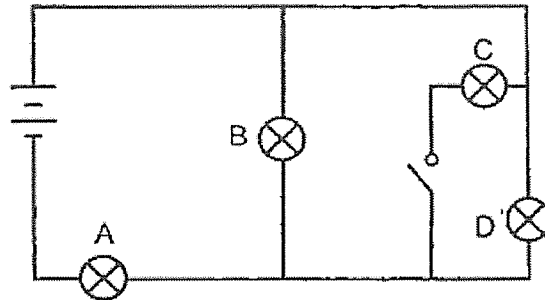

Which of the following bulb(s) can be turned on or off using the switch?

- (1) C only
  - (2) A and B only
  - (3) C and D only
  - (4) A, B and D only
- 27 The circuit below consists of a battery, two bulbs and two switches.

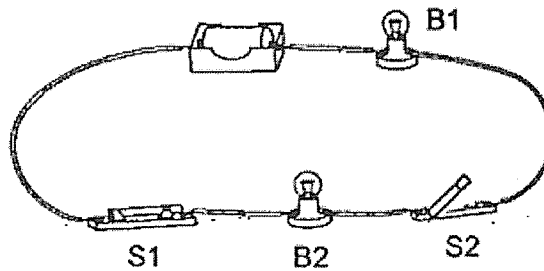

Based on the diagram above, which of the following statements about the circuit are true?

- A Both bulbs do not light up.
  - B Only one of the bulbs will light up.
  - C An electric current will flow through switch S1
  - D Switch S1 is closed but switch S2 is open, so the circuit is an open circuit.
- (1) A and D only
  - (2) B and C only
  - (3) A, C and D only
  - (4) B, C and D only

- 28 The diagram below shows a circuit board and a circuit tester. There are five metal pins, P, Q, R, S and T, fixed onto the board. There are some hidden wires connected to the pins.

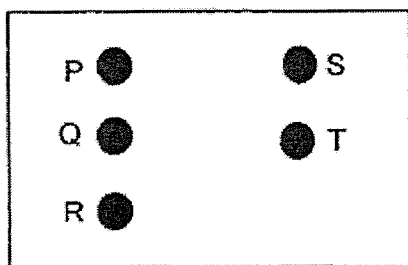

circuit board

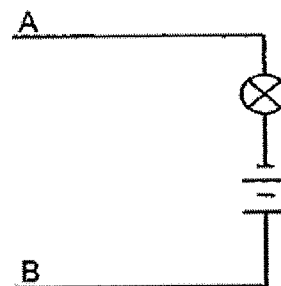

circuit tester

The bulbs would light up when some of the pins formed a closed circuit with the circuit tester. The results were recorded in the table below.

Pin connected to A	Pin connected to B	Did the bulb light up?
Q	P	No
R	P	Yes
S	Q	No
T	S	Yes

Which of the following correctly shows how the pins on the circuit board were connected?

(1)

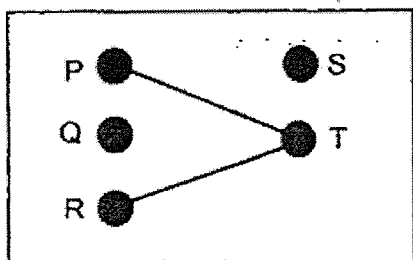

(2)

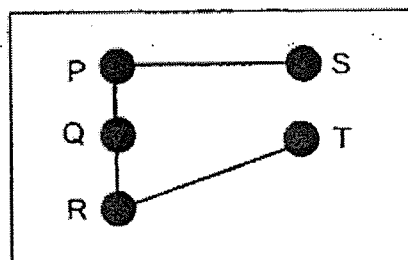

(3)

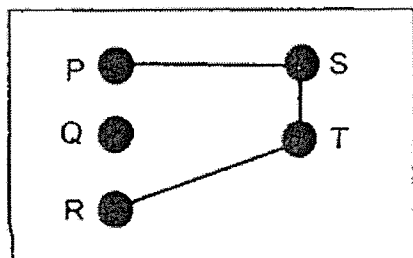

(4)

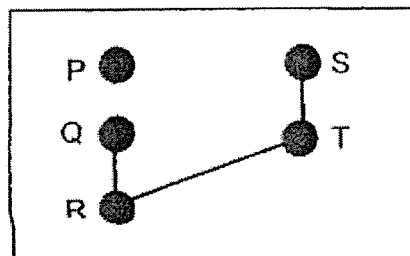

(Go on to the next page)



NAN HUA PRIMARY SCHOOL  
PRELIMINARY EXAMINATION 2023  
PRIMARY FIVE

SCIENCE  
(BOOKLET B)

Total Time for Booklets A and B: 1 hour 45 minutes

**INSTRUCTIONS TO CANDIDATES**

1. Write your name, index number and class in the spaces provided below.
2. Do not turn over the page until you are told to do so.
3. Follow all instructions carefully.
4. Answer all questions.
5. Use dark blue or black ballpoint pen to write your answers in the space provided for each question.
6. Do not use correction fluid/tape or highlighter.

**Marks Obtained**

Booklet B 

	/ 44
--	------

Name: \_\_\_\_\_ (     )

Form Class: P5 \_\_\_\_\_

Teaching Group: 5S

Date: 24 October 2023

Parent's Signature:

---

This booklet consists of 15 printed pages and 1 blank page.

Write your answers to question 29 to 39, write your answers in this booklet.

The number of marks available is shown in brackets [ ] at the end of each question or part question.

(44 marks)

- 29 Tina put a plant into a container filled with red-coloured water as shown below. She left the set-up overnight.

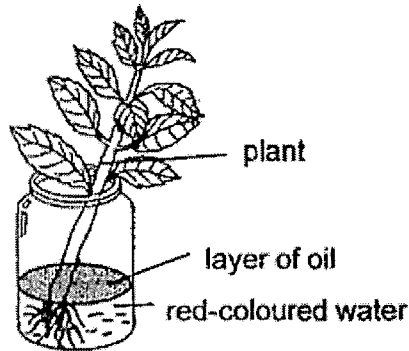

- (a) Tina observed the water level in the container was lower after a few hours. Give a reason. [1]

---



---

- (b) Tina observed that the leaves of the plant turned red. Name the part of the stem that allowed the water to reach the leaves. [1]

---

- (c) Explain why the layer of oil was used in this experiment. [2]

---



---



---

Score	4
-------	---

30 Ben ran around the park for 30 minutes. The table below shows his heart rate before and during his run.

Heart rate at rest	Heart rate during running
58 beats per min	180 beats per min

(a) Explain why Ben's heart rate increased when he was running. [2]

---



---



---

The graph below shows the volume of blood supplied per minute to Ben's legs and small intestine at rest and during his run.

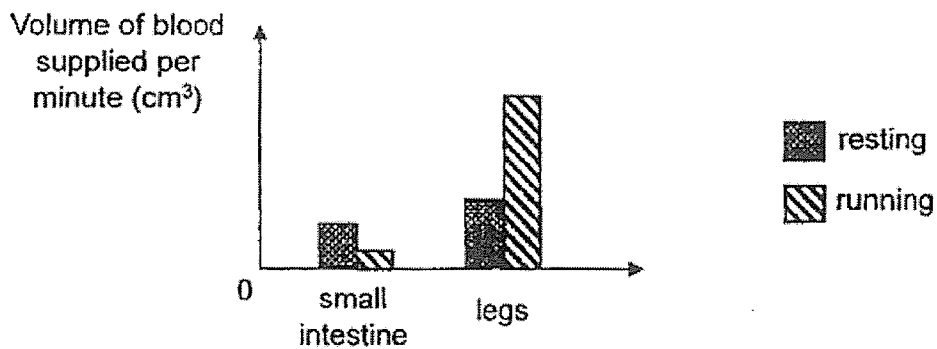

(b) Using the graph above, explain how running after a meal affects the absorption of digested food in the small intestine. [1]

---



---

(c) How does the heart help the digested food absorbed from the small intestine reach the rest of the body? [1]

---



---

(Go on to the next page)

Score	4
-------	---

31 The diagram below shows part T which is found on the leaf of a land plant.

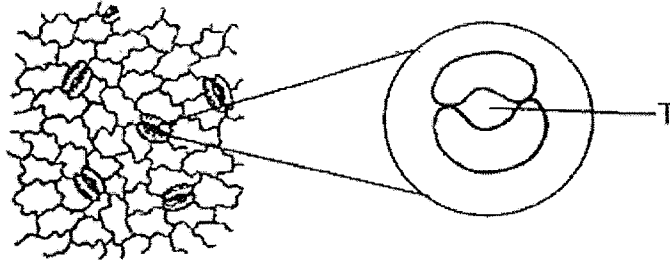

(a) Which of the following statement(s) is/are correct about part T? Put a tick in the correct box(es). [1]

Statements	Tick (✓)
Part T allows for gaseous exchange.	
Part T allows the plant to absorb sunlight to make food.	
More of part T can be found on the underside of the leaf.	

(b) State a difference in the process of gas exchange in plants and in humans. [1]

---



---

John took two leaves of the same size, R and S, from the same plant as shown below. Leaf R is completely green while leaf S has both green and white parts. He placed both leaves in a beaker filled with water and substance X. Substance X increases the amount of carbon dioxide in water.

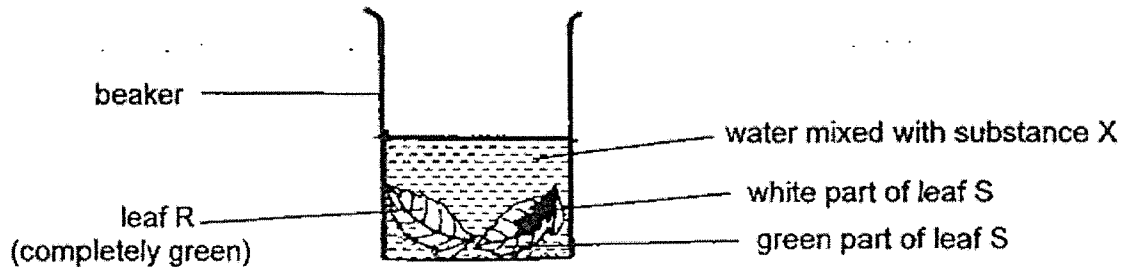

The set-up was placed in a brightly-lit room. After some time, John observed one leaf floated up to the water surface first.

(c) Which leaf, R or S, floated up first? Explain why. [2]

---



---



---

Score	4
-------	---



- 32 Raju examined three different cells, cell A, cell B and cell C, under a microscope and recorded his observations in the table below. A tick (✓) indicates the presence of the part in the cell.

Cell Parts	Cell A	Cell B	Cell C
cell membrane	✓	✓	✓
cytoplasm	✓	✓	✓
nucleus	✓	✓	✓
cell wall		✓	✓
chloroplast		✓	

- (a) Based on the table above, state one difference between cell A and cell C. [1]

---



---

- (b) Raju identified cell C as an animal cell. Do you agree with him? Explain why. [1]

---



---

- (c) Which cell, A, B or C, most likely comes from the leaf of a plant? Why? [1]

---



---

- (d) Based on the table above, which cell(s) can reproduce? Give a reason. [1]

---



---

(Go on to the next page)

Score	4
-------	---

33 The diagram below shows two fruits, X and Y, from different plants.

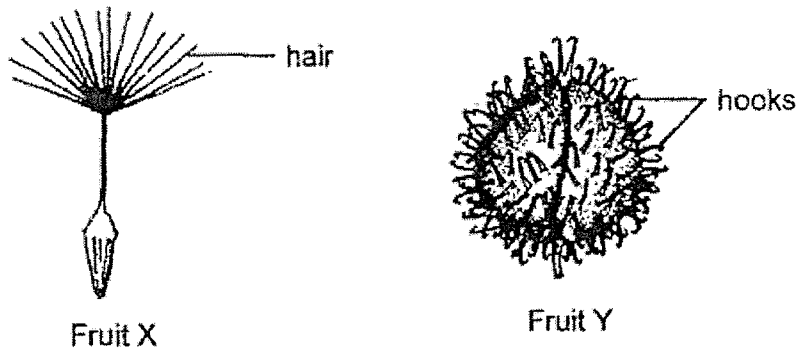

(a) Which fruit, X or Y, is likely to be dispersed by an animal? Explain why. [2]

---



---



---

(b) The diagram below shows where the three plants bearing fruits X, Y and a third plant bearing fruit Z, can be found on an island.

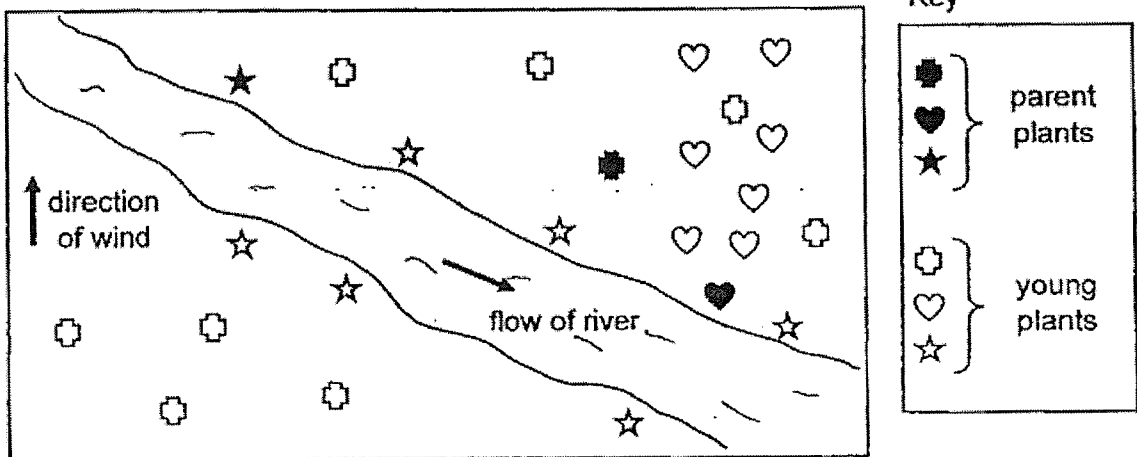

(i) Complete the table below by identifying the plants that bear fruits, X and Y. [1]

Symbol	Plant bearing fruits
+	
☆	Z
♥	

- (ii) State one characteristic of fruit Z to explain its dispersal method as shown in the diagram. [1]

---

---

---

(Go on to the next page)

Score	
-------	---

- 34 Michael tied object X on top of his plastic toy car as shown in diagram 1. He placed them on a track which allowed the car to only travel in a straight line. At the end of the track, he attached a strong magnet to the wall as shown.

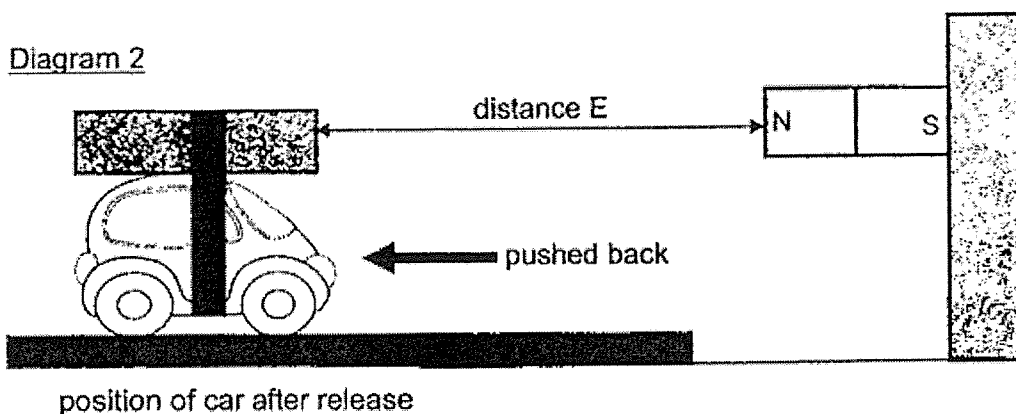
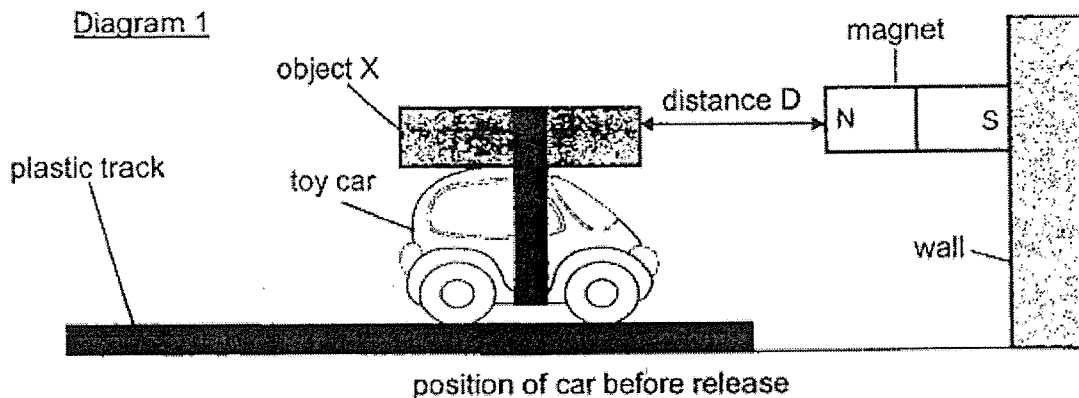

Michael pushed the car with object X towards the magnet. At distance D, he released the car very gently. The car with object X moved backwards and was found at distance E from the magnet. He repeated the steps with decreasing distance D each time and measured the new distance E as shown in the table below.

Distance D (cm)	Distance E (cm)
3	3
2	5
1	8

- (a) What could object X be?

[1]

- (b) Explain why the car with object X moved backwards along the track when Michael released it. [2]

---

---

---

---

- (c) State the relationship between distance D and distance E. [1]

---

---

(Go on to the next page)

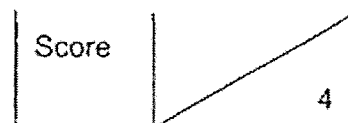

35 The diagram below shows the human female reproductive system.

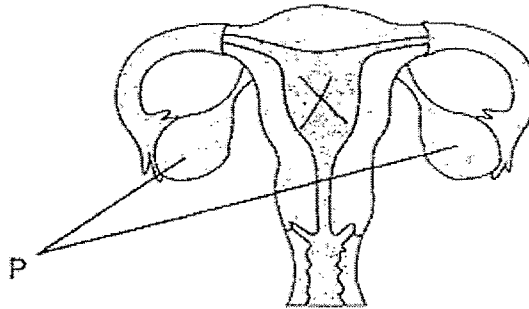

(a) Label 'X' in the diagram above to show the part where the fertilised egg developed into a foetus. [1]

(b) During the mating process, thousands of sperms are released into the female reproductive system. Explain how this helps in the process of fertilisation. [1]

---



---

(c) Will it be possible for fertilisation to take place naturally if both parts P were removed? Explain your answer. [1]

---



---

Score	3
-------	---

36 Peter has two identical table lamps with different bulbs. He wanted to find out how the type of bulb affects the temperature of its surroundings. He placed each table lamp in a clear plastic container as shown below.

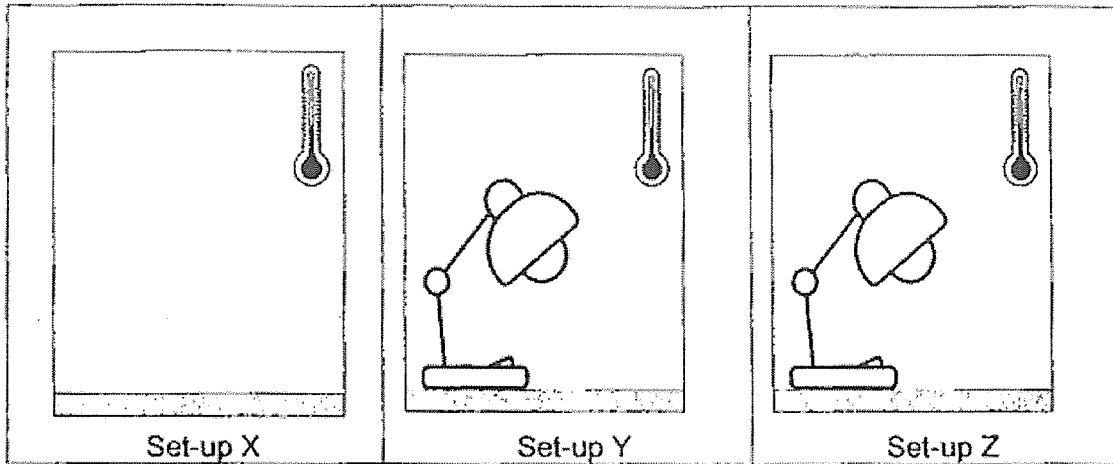

Peter recorded the initial temperature of the air inside the plastic container and the temperature of the air after the table lamps were switched on for one hour in the table below.

	Control set-up X	Set-up Y	Set-up Z
Initial temperature (°C)	27	27	27
Temperature after one hour (°C)	27	29	31

(a) What is the changed variable in this experiment? [1]

---

(b) Which set-up has a more energy-saving bulb? Explain your answer. [2]

---



---



---



---

(c) Explain the purpose of the control set-up X. [1]

---

(Go on to the next page)

Score	4
-------	---

- 37 Sandy sets up an experiment to count the number of identical object P by placing them between a torch and a light sensor. The light sensor shows a reading of 100 units without any material placed between the torch and the light sensor.

In the set-up as shown below, a conveyor belt is set to move at a constant speed.

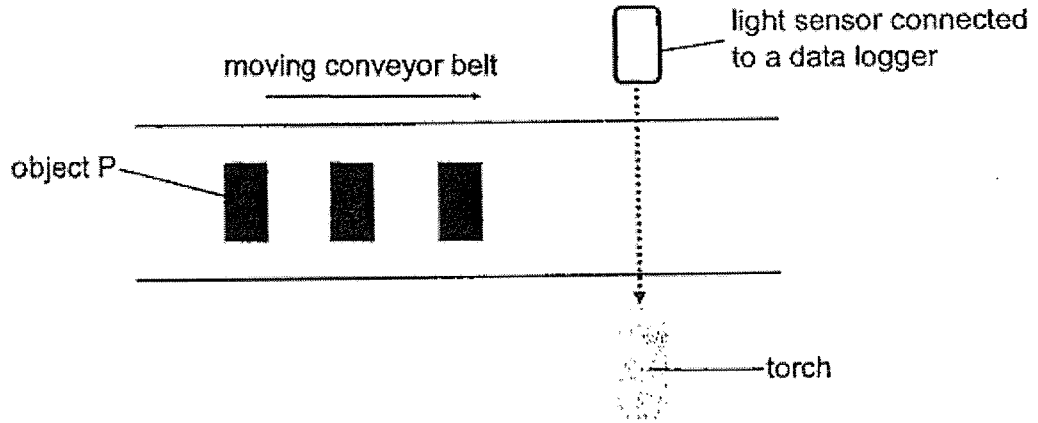

The light sensor detects the changes in the amount of light as each object P moves along the conveyor belt.

The graph below shows the results.

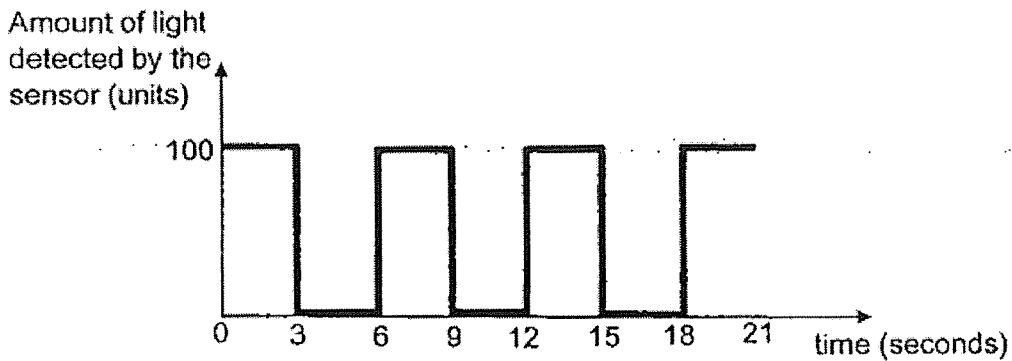

- (a) Explain how Sandy is able to count the number of object P using the set-up. [2]

---



---



---



---



- (b) Based on the graph, how many objects passed the sensor in 21 seconds? [1]

---

- (c) Suggest two ways in which the objects can be counted more quickly. [2]

---

---

---

---

(Go on to the next page)

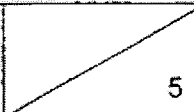
Score	
-------	---

38 The diagram shows an electric circuit.

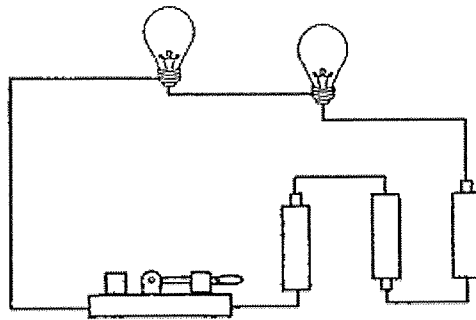

(a) Draw a circuit diagram, using symbols, to represent the electric circuit shown above. [2]

(b) Describe and explain what will happen if one of the bulbs fused. [1]

---



---



---



---

(c) What will happen to the brightness of the light bulbs if another light bulb is added in series to other bulbs in the electric circuit? [1]

---



---

Score	4
-------	---

- 39 The diagram below shows two circuits, A and B. Identical batteries and iron rods were used in the circuit.

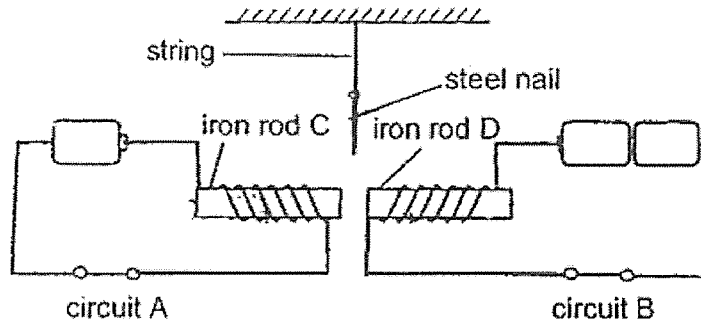

- (a) Compare the magnetic strength of iron rods C and D when both switches were closed. Which rods, C or D, had a stronger magnetic strength? [1]
- 
- (b) What would happen to the suspended steel nail when both switches were closed? [1]
- 

The experiment was repeated with the set-up shown below.

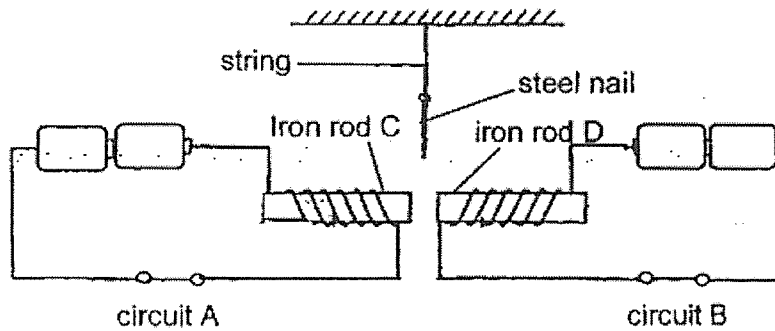

- (c) Explain why the steel nail remained in the same position and did not move. [2]
- 
- 
- 
- 

End of Paper

Score	4
-------	---



Nan Hua Primary School  
 END OF YEAR EXAMINATION 2023  
 Primary Five Science  
 Student's Answer Key

Section A

Question	Answer	Question	Answer	Question	Answer
1	2	11	3	21	2
2	2	12	3	22	3
3	2	13	2	23	4
4	2	14	2	24	3
5	4	15	1	25	4
6	4	16	2	26	1
7	2	17	2	27	1
8	2	18	4	28	3
9	4	19	4		
10	2	20	4		

Section B

Qn	Answer	Marks								
29a	The <b>roots</b> (of the plant) <b>absorbed</b> / took in some water.	1m								
29b	water-carrying tubes / xylem	1m								
29c	The <b>layer of oil prevents the water in the</b> container from <b>evaporating</b> so that we can be sure that the <b>decrease</b> in water level <b>is due to the roots taking in water.</b>	2m								
30a	Ben's heart needs to pump blood faster/ pump more blood containing more oxygen and digested food <b>to release more energy</b> to produce/ remove more carbon dioxide/ waste.	2m								
30b	Less volume of blood received by the small intestine should be <b>less</b> during running. <b>Less digested food</b> will be absorbed into the bloodstream.	1m								
30c	The heart will pump the blood which contains digested food <b>through the blood vessels to the rest of the body.</b>	1m								
31a	<table border="1"> <thead> <tr> <th>Statements</th> <th>Tick (✓)</th> </tr> </thead> <tbody> <tr> <td>Part T allows for gaseous exchange.</td> <td>✓</td> </tr> <tr> <td>Part T allows the plant to absorb sunlight to make food.</td> <td></td> </tr> <tr> <td>More of part T can be found on the underside of the leaf.</td> <td>✓</td> </tr> </tbody> </table>	Statements	Tick (✓)	Part T allows for gaseous exchange.	✓	Part T allows the plant to absorb sunlight to make food.		More of part T can be found on the underside of the leaf.	✓	1m or 0m
Statements	Tick (✓)									
Part T allows for gaseous exchange.	✓									
Part T allows the plant to absorb sunlight to make food.										
More of part T can be found on the underside of the leaf.	✓									

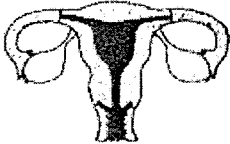
31b	Gas exchange in plants takes place through tiny openings on the leaves/stomata but gas exchange in humans takes place in the lungs.	1m								
31c	Leaf R. Leaf R has more green parts as compared to Leaf S. It contains more green pigment/ chlorophyll [1/2]. Hence, leaf R can take in more carbon dioxide [1] and give out oxygen through the tiny openings/stomata [1/2] and will float to the surface first.	2m								
32a	Cell A does not have a cell wall but cell C has a cell wall.	1m								
32b	No. An animal cell has no cell wall but cell C has a cell wall.	1m								
32c	Cell B. It has chloroplasts (which helps the leaf trap light to make food).	1m								
32d	Cells A, B, and C. All 3 cells have a nucleus which is responsible for cell reproduction.	1m								
33a	Fruit Y. Fruit Y has hooks which cling on/hook on to the hair/fur of the animal unlike fruit X has hair which helps to float longer in air and is likely to be dispersed by wind.	2m								
33b(i)	<table border="1" style="width: 100%; border-collapse: collapse;"> <thead> <tr> <th style="width: 30%;">Symbol</th> <th style="width: 70%;">Plants bearing fruits</th> </tr> </thead> <tbody> <tr> <td style="text-align: center;">⊕</td> <td style="text-align: center;">Y</td> </tr> <tr> <td style="text-align: center;">★</td> <td style="text-align: center;">Z</td> </tr> <tr> <td style="text-align: center;">♡</td> <td style="text-align: center;">X</td> </tr> </tbody> </table>	Symbol	Plants bearing fruits	⊕	Y	★	Z	♡	X	1m
Symbol	Plants bearing fruits									
⊕	Y									
★	Z									
♡	X									
33b(ii)	It has a fibrous husk that traps air which enables it to float and be dispersed/carried by water.	1m								
34a	Magnet	1m								
34b	The like poles of the object X and magnet were facing each other. Hence the object X is repelled/pushed away from the magnet.	2m								
34c	As the distance D increases, the distance E decreases.	1m								
35a	 <p>anywhere in the uterus</p>	1m								
35b	It increases the chances of the egg being fertilised./ to ensure the egg is fertilised successfully.	1m								
35c	No. Part P releases the female sex cell/egg cells. Without part P, there would be no mature egg cells released to fuse with the sperm, hence no fertilisation can occur.	1m								

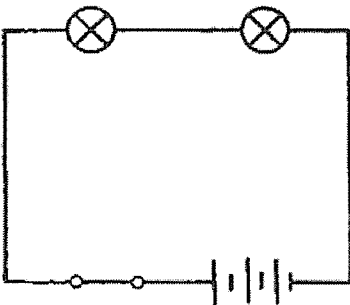
36a	The type of light bulb.	1m
36b	Set-up Y. The table shows that the temperature gained by the air in set-up Y is lower than that of the temperature gained by the air in set-up Z. As less heat is produced from table lamp in Y [1], it is more energy-saving.	2m
36c	To compare and confirm/ensure that the change in the temperature in set-ups Y and Z is due to the heat produced by the table lamps and not any other factors.	1m
37a	When object P passes through the light source, the light from the light source is blocked./ P is opaque and does not allow light to pass through.	2m
37b	3 objects	1m
37c	Increase the speed of the conveyor belt.  Place the objects nearer to each other. Have smaller gap between the objects.	1m  1m
38a		1m
38b	If one bulb is fused, the circuit will be open and <b>no electric current</b> is able to pass through the circuit / bulb. Hence, <b>the other bulb will not</b> light up too.	1m
38c	The brightness of the bulbs will decrease <b>/be dinner</b> .	1m
39a	Iron rod <b>D</b>	1m
39b	The steel nail on the string will swing towards the right/iron rod D.	1m
39c	Both the iron rods have the same magnetic strength, hence the <b>pull</b> between the rods and the steel nail are the same.	2m

END

