



2023 PRIMARY 5 END-OF-YEAR EXAMINATION

Name: _____ ()

Date: 24 October 2023

Class: Primary 5 ()

Time: 8.00 a.m. - 9.00 a.m.

Parent's Signature: _____

Marks: _____ / **100**

Paper 1 comprises 2 booklets, A and B.

MATHEMATICS PAPER 1 (BOOKLET A)

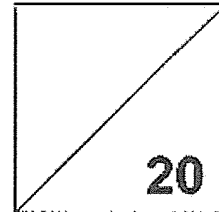

INSTRUCTIONS TO CANDIDATE

1. Write your name, class and register number.
2. Do not turn over this page until you are told to do so.
3. Follow all instructions carefully.
4. Answer all questions.
5. **Shade your answers in the Optical Answer Sheet (OAS) provided.**
6. The use of calculators is **NOT** allowed.

Questions 1 to 10 carry 1 mark each. Questions 11 to 15 carry 2 marks each.
For each question, four options are given. One of them is the correct answer.
Make your choice (1, 2, 3 or 4).

Shade the oval (1, 2, 3 or 4) on the Optical Answer Sheet.

(20 marks)

1. In 9.358, which digit is in the hundredths place?
 - (1) 9
 - (2) 8
 - (3) 3
 - (4) 5

2. Dan participated in a school activity from 9 a.m. to 2 p.m. How many hours did the school activity last?
 - (1) 5
 - (2) 6
 - (3) 7
 - (4) 9

3. Round 71 809 to the nearest thousand.
 - (1) 71 000
 - (2) 71 800
 - (3) 71 810
 - (4) 72 000

4. AB and CD are straight lines. Which of the following is true?

- (1) $\angle w = \angle y$
- (2) $\angle x = \angle z$
- (3) $\angle w + \angle y = 180^\circ$
- (4) $\angle x + \angle y + \angle z = 180^\circ$

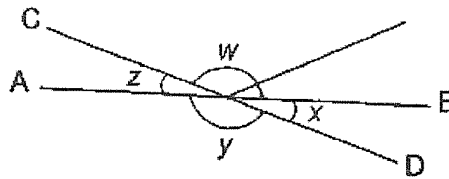

5. Which of the following is equal to $4\frac{5}{6}$?

- (1) $\frac{29}{6}$
- (2) $\frac{26}{6}$
- (3) $\frac{25}{6}$
- (4) $\frac{20}{6}$

6. What percentage of the shapes are squares ?

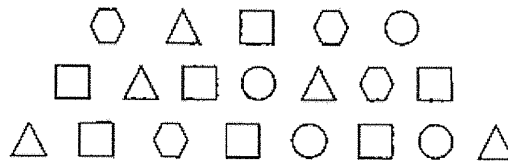

- (1) 35%
- (2) 30%
- (3) 25%
- (4) 20%

7. Which of the following is the related height of base AC?

- (1) AB
- (2) BC
- (3) CE
- (4) DB

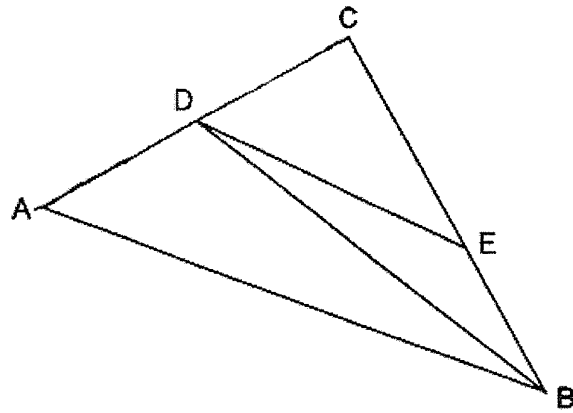

8. Bala has \$1200. He saves \$800 and spends the remainder. What fraction of his savings is his spending?

- (1) $\frac{1}{3}$
- (2) $\frac{2}{5}$
- (3) $\frac{1}{2}$
- (4) $\frac{2}{3}$

9. At a bookshop, the number of books sold in July is equal to the total number of books sold from April to June. Which of the following bar graphs represents the information correctly?

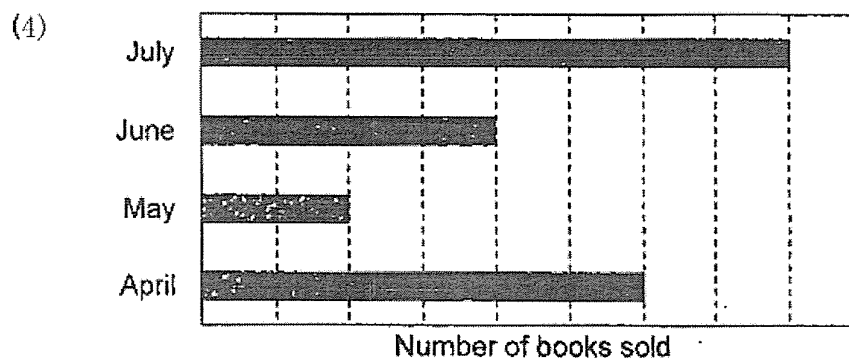
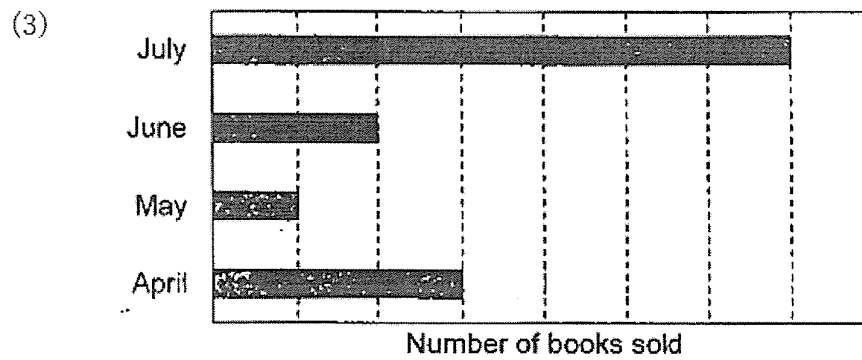
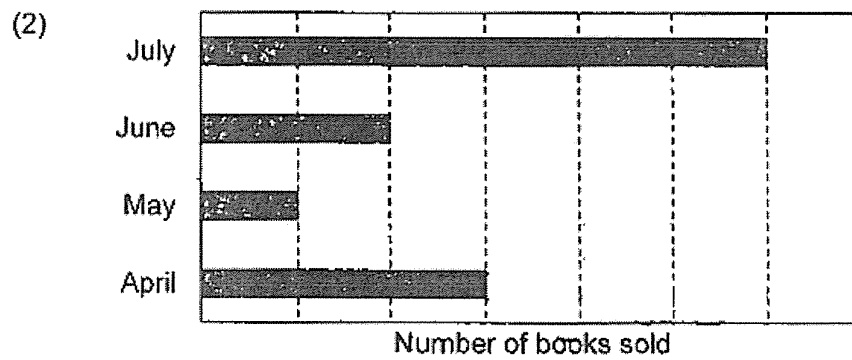
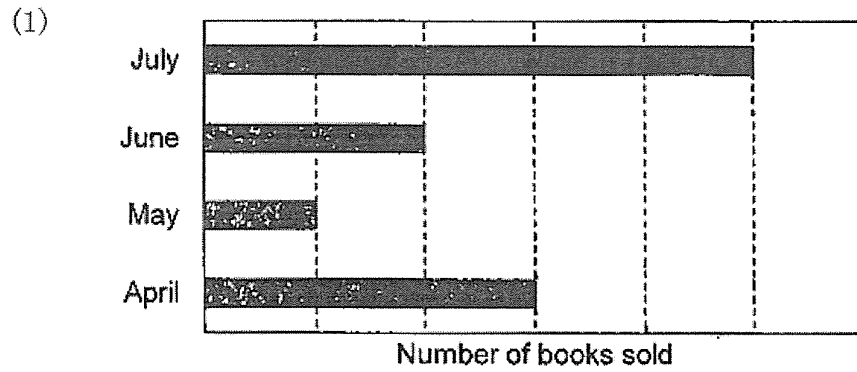

10. Carl gave away $\frac{1}{4}$ of his stamps and sold 60% of the remainder. What percentage of his stamps was left?

- (1) 15%
- (2) 30%
- (3) 40%
- (4) 45%

11. What is the value of $(2 + 2 \times 2) + 2 + 2 \times 2$?

- (1) 7
- (2) 8
- (3) 10
- (4) 12

12. Arrange the following from the lightest to the heaviest:

7.45 kg	$7\frac{4}{5}$ kg	7 kg 405 g
---------	-------------------	------------

- | | <u>Lightest</u> | | <u>Heaviest</u> |
|-----|-------------------|-------------------|-------------------|
| (1) | 7 kg 405 g | 7.45 kg | $7\frac{4}{5}$ kg |
| (2) | 7 kg 405 g | $7\frac{4}{5}$ kg | 7.45 kg |
| (3) | $7\frac{4}{5}$ kg | 7.45 kg | 7 kg 405 g |
| (4) | 7.45 kg | $7\frac{4}{5}$ kg | 7 kg 405 g |

13. At a shop, the ratio of the number of erasers to the number of pens to the number of rulers is 5 : 3 : 2. There is a total of 280 erasers and rulers. How many pens are there?

- (1) 168
- (2) 120
- (3) 105
- (4) 84

14. A rectangular tile is printed with square patterns. The perimeter of the tile is 32 cm. What is the area of each square pattern?

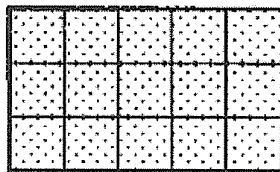

- (1) 60 cm^2
 - (2) 2 cm^2
 - (3) 8 cm^2
 - (4) 4 cm^2
15. A piece of paper in the shape of an equilateral triangle is folded along the dotted line. Find $\angle y$.

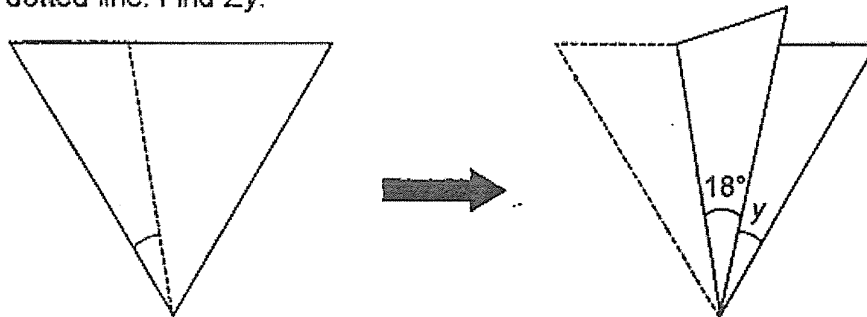

- (1) 18°
- (2) 20°
- (3) 24°
- (4) 42°

End of Booklet A

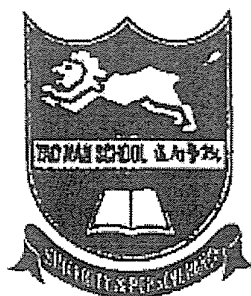

2023 PRIMARY 5 END-OF-YEAR EXAMINATION

Name: _____ ()

Date: 24 October 2023

Class: Primary 5 ()

Time: 8.00 a.m. - 9.00 a.m.

Parent's Signature: _____

Paper 1 comprises 2 booklets, A and B.

MATHEMATICS PAPER 1 (BOOKLET B)

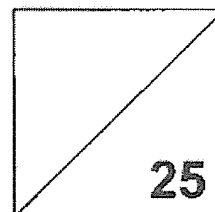

INSTRUCTIONS TO CANDIDATE

1. Write your name, class and register number.
2. Do not turn over this page until you are told to do so.
3. Follow all instructions carefully.
4. Answer all questions. Show your working clearly.
5. Write your answers in this booklet.
6. Use a dark blue or black ballpoint pen to write your answers.
7. Do not use correction tape or highlighters for your solutions.
8. The use of calculators is **NOT** allowed.

Questions 16 to 20 carry 1 mark each. Write your answers in the spaces provided.
For questions which require units, give your answers in the units stated. (5 marks)

16. Express 205 minutes in hours and minutes.

Ans: _____ h _____ min

17. Find the value of $902 \div 5$. Express your answer as a decimal.

Ans: _____

18. Express $1\frac{3}{20}$ as a decimal.

Ans: _____

19. What is 8% GST of the school bag?



Ans: \$ _____

20. The line graph shows the amount of rice left in a container at the start of each day from Day 1 to Day 4.

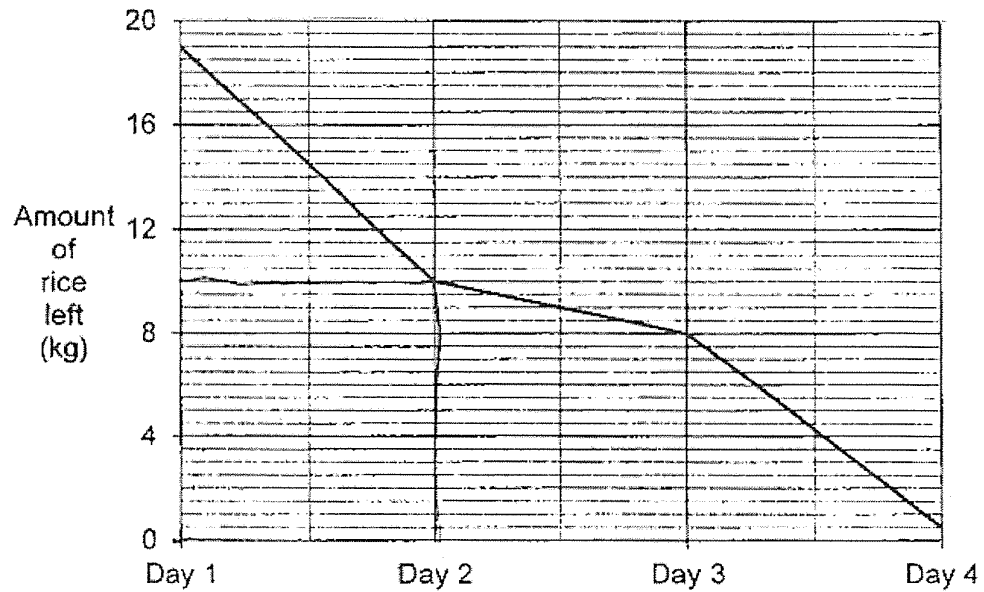

What is the amount of rice left in the container at the start of Day 2?

Ans: _____ kg

Questions 21 to 30 carry 2 marks each. Show your working clearly in the space provided for each question and write your answers in the spaces provided. For questions which require units, give your answers in the units stated. (20 marks)

21. Find the value of A in the ratio.

$$63 : 56 : A = 81 : 72 : 27$$

Ans: _____

22. The table shows the time taken by 6 runners to complete a race.

Runner	Time (s)
A	28.4
B	29.5
C	27.7
D	28.9
E	29.8
F	27.6

Who was last in the race?

Ans: _____

23. How much does 3.5 kg of durians cost?

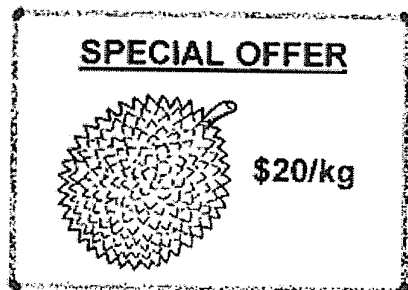

Ans: \$ _____

24. The figure shows five roads drawn on a map in a square grid.

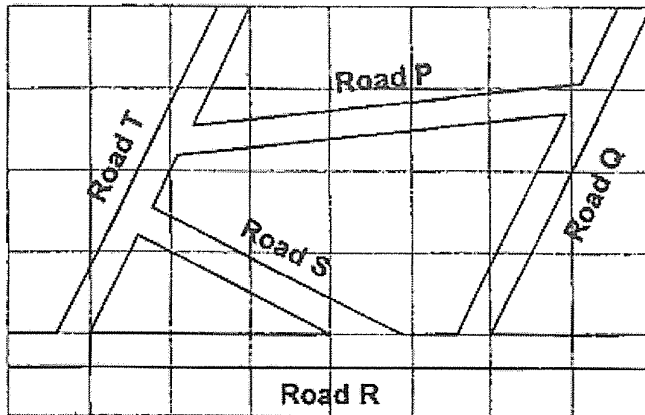

- (a) Name two roads that are parallel to each other.
 (b) Name two roads that are perpendicular to each other.

Ans: (a) Road _____ and Road _____

(b) Road _____ and Road _____

25. From the square marked 'A', a chess piece is moved 2 squares south-west and 1 square east. Mark the new position of the chess piece with an 'X'.

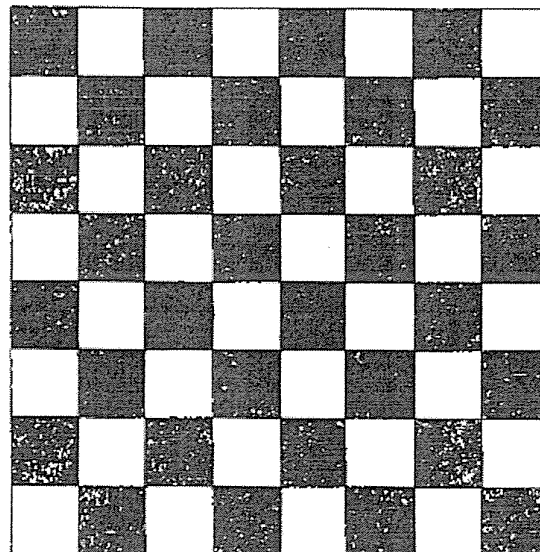

26. Put a tick (✓) in the box that represents the top view of Solid Z.

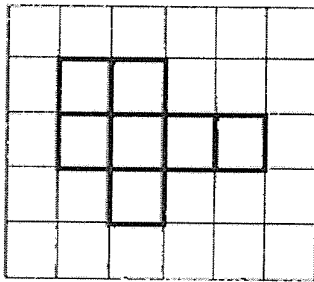
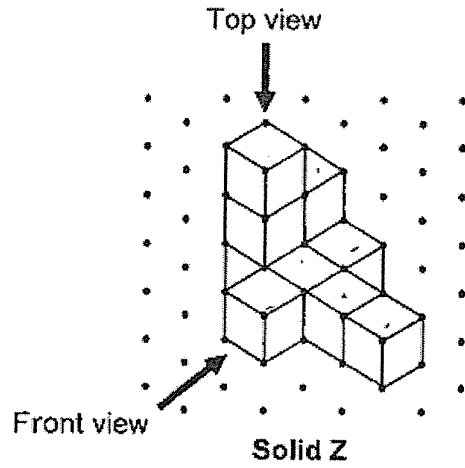

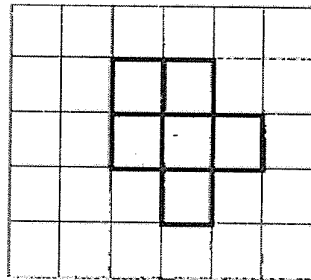

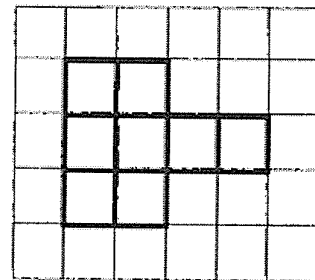

27. In the scale below, round the value marked X to 1 decimal place.

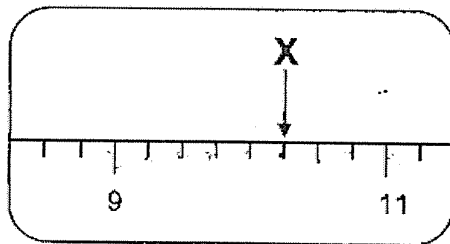

Ans: _____

28. A repeated pattern is formed using the numbers 0, 1 and 2.
The first 13 numbers are shown below.

0	1	2	0	2	1	0	1	2	0	2	1	0
1st	2nd	3rd										13th

What is the average value of the first 30 numbers?

Ans: _____

29. 6 jugs of water can fill $\frac{5}{8}$ of a pail. Another 3 jugs and 6 cups of water are needed to fill the pail completely. How many cups of water can the pail hold?

Ans: _____

30. Ali had \$36 of 20-cent and 50-cent coins in his piggy bank.
There were twice as many 20-cent as 50-cent coins.
Find the number of 50-cent coins in the piggy bank.

Ans: _____

End of Booklet B

End of Paper 1



2023 PRIMARY 5 END-OF-YEAR EXAMINATION

Name: _____ () Date: 24 October 2023

Class: Primary 5 () Time: 10.30 a.m. – 12.00 noon

Parent's Signature: _____

MATHEMATICS

PAPER 2

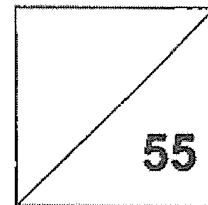

INSTRUCTIONS TO CANDIDATE

1. Write your name, class and register number.
2. Do not turn over this page until you are told to do so.
3. Follow all instructions carefully.
4. Answer all questions. Show your working clearly.
5. Write your answers in this booklet.
6. Use a dark blue or black ballpoint pen to write your answers.
7. Do not use correction tape or highlighter for your solutions.
8. You are **allowed** to use a calculator.

Questions 1 to 5 carry 2 marks each. Show your working clearly and write your answers in the spaces provided. For questions which require units, give your answers in the units stated. (10 marks)

1. The figure is made up of a rectangle and an equilateral triangle. Find $\angle a$.

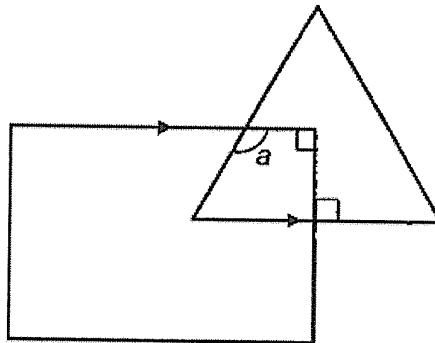

Ans: _____ °

2. Peter was given a sum of money. He gave $\frac{4}{5}$ of the money to his parents and shared the rest of the money equally with his 2 sisters. His parents received \$240. How much did Peter receive in the end?

Ans: \$ _____

3. Ms Lim bought 25 boxes of doughnuts for a party. Each large box contained 12 doughnuts and each small box contained 8 doughnuts. There were 252 doughnuts in all. How many large boxes of doughnuts did she buy?

Ans: _____

4. A tank contains 12.8 ℓ of water. Mr Lee pours 3 pails of water, each containing 0.65 ℓ of water, into the tank without spilling. Find the volume of water in the tank in the end.

Ans: _____ ℓ

5. A florist takes 25 minutes to make a bouquet of flowers. How much time is needed to make 9 such bouquets of flowers?

Ans: _____ h

For questions 6 to 17, show your working clearly in the space provided for each question and write your answers in the spaces provided. The number of marks available is shown in brackets [] at the end of each question or part-question.

(45 marks)

6. Mr Tan bought some sweets for his students.
When he gave each student 3 sweets, he would have 4 sweets left over.
When he gave each student 4 sweets, he would need another 2 sweets.
How many sweets did Mr Tan buy?

Ans: _____ [3]

7. Bala had 3 m of wire. He cut some of the wire to bend into the shape shown in the figure. All the sides are equal in length. He then had 0.4 m of wire left. Find the length of 1 side of the shape. Give your answer in metres, correct to 2 decimal places.

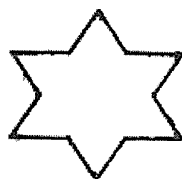

Ans: _____ [3]

8. Ali needs 1 full tank of spring water for a gardening job. Given that 1 ℓ of spring water costs \$0.65, how much money does Ali need for a tank shown below?

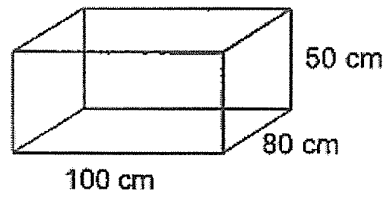

Ans: _____ [3]

9. Mr Shelby took a bank loan of \$90 000 to buy a car. The bank charged him an interest rate of 5% per year. He paid the loan in equal monthly payments over 2 years. What was the amount he had to pay each month?

Ans: _____ [3]

10. The figure is not drawn to scale and all lines meet at right angles.

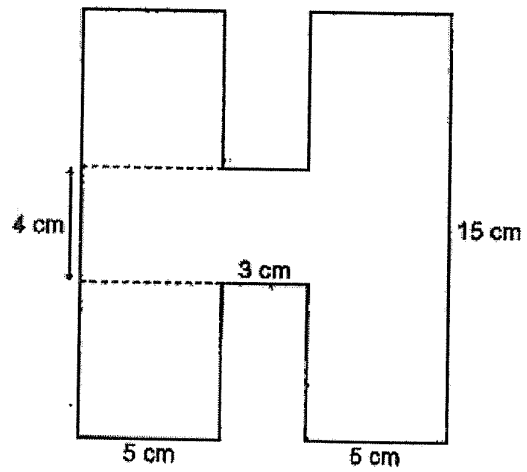

Find the perimeter of the figure.

Ans: _____ [3]

11. One afternoon, Ahmad, Benny and Charlie took turns to play games on 2 computers from 2 p.m. to 4.30 p.m. At any time, 2 of them played on the computers while the other one watched. Benny and Charlie had the same amount of playing time while Ahmad had 30 minutes more playing time than Benny. Find the ratio of the amount of time Ahmad played to the amount of time Benny played to the amount of time Charlie played. Give your answer in the simplest form.

Ans: _____ [4]

12. The heights of 4 children were shown in the table below.

Name	Height (m)
Aini	1.42
Ben	1.43
Caleb	1.37
Devi	1.26

- (a) Find the average height of the 4 children. Give your answer in metres.

Ans: (a) _____ [2]

- (b) The average height of the children became 1.34 m when another child, Eric, joined the group. Find Eric's height.

Ans: (b) _____ [2]

13. Mr Lee started making shirts at 9 a.m. He took 1 h 40 min to make each shirt. After making each shirt, he took a 15-min break. He finished making all the shirts at 6.20 p.m. How many shirts did he make?

Ans: _____ [4]

14.

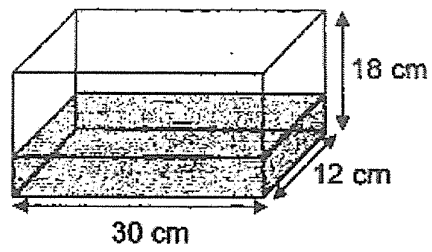

- (a) Given $\frac{1}{3}$ of the rectangular tank above was filled with water, find the volume of water in the tank. Give your answer in litres.

Ans: (a) _____ [2]

- (b) Find the volume of water needed to fill the tank above to half its height.

Ans: (b) _____ [2]

15. Four identical triangles are used to form the figure. Find the unshaded area of the figure.

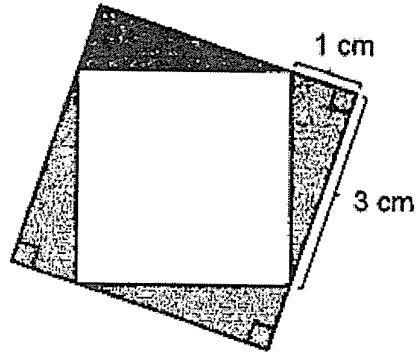

Ans: _____ [4]

16. The first four figures of a pattern are shown below.

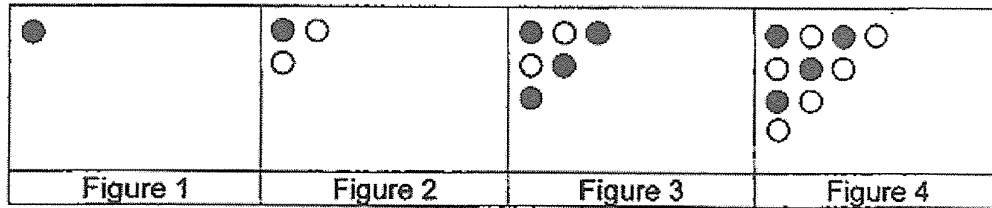

The table shows the number of grey and white beads used for each figure.

Figure	Number of Grey Beads	Number of White Beads	Total Number of Beads
1	1	0	1
2	1	2	3
3	4	2	6
4	4	6	10
5		6	

[1]

(a) Fill in the table for Figure 5.

(b) Find the number of white beads for Figure 21.

Ans: (b) _____ [2]

(c) Each of the statements is either true, false or not possible to tell from the information given. For each statement, put a tick (✓) to indicate your answer.

Statement	True	False	Not possible to tell
i) The number of white beads in each figure is always even.			
ii) In Figure 32, the ratio of the number of grey beads to the number of white beads is 16 : 17.			

[2]

17. Caili and Deepa had different amounts of money. After Caili spent 25% of her money and Deepa spent $\frac{2}{3}$ of her money, both of them had the same amount of money left. The total amount of money left was \$480. Find the total amount of money they had at first.

Ans: _____ [5]

End of Paper 2

SCHOOL : TAO NAN SCHOOL
 LEVEL : PRIMARY 5
 SUBJECT : MATHEMATICS
 TERM : 2023 SA2

PAPER 1 (BOOKLET A)

Q1	4	Q2	1	Q3	4	Q4	2	Q5	1
Q6	1	Q7	2	Q8	3	Q9	2	Q10	2
Q11	1	Q12	1	Q13	2	Q14	4	Q15	3

PAPER 1 (BOOKLET B)

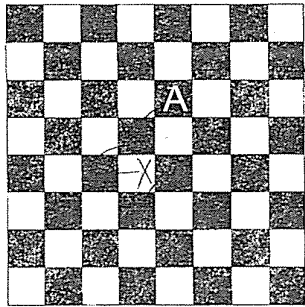
Q16	3h 25min
Q17	180.4
Q18	1.15
Q19	\$3.20
Q20	10kg
Q21	21
Q22	E
Q23	\$70
Q24a	T and Q
Q24b	T and S
Q25	
Q26	Box 1
Q27	10.3
Q28	1

Q29	96
Q30	40

Paper 2

Q1	Angle A = $180 - 60 = 120^\circ$
Q2	Total units = 5u Units given to parents = 4u $4u = \$240$ $1u = \$60$ Amount Peter received = $\$60 \div 3 = \20
Q3	Assume all are small $25 \times 8 = 200$ $252 - 200 = 52$ $12 - 8 = 4$ $52 \div 4 = 13$
Q4	$12.8L + (0.65L \times 3) = 14.75L$
Q5	$25\text{min} \times 9 = 225\text{min}$ $225\text{min} = 3\text{h } 45\text{min} = 3\frac{3}{4}\text{ h}$
Q6	Use guess and check method 22 sweets
Q7	$3 - 0.4 = 2.6\text{m}$ $2.6\text{m} \div 12 = 0.22\text{m}$
Q8	Volume of full tank = $100 \times 80 \times 50 = 400L$ Money needed = $400 \times \$0.65 = \260
Q9	Total interest over 2 years = $0.05 \times \$90000 \times 2 = \9000 Total amount to be repaid = $\$900000 + \$9000 = \$909000$ Amount paid each month = $\$909000 \div 24 = \37875
Q10	$15\text{cm} - 4\text{cm} = 11\text{cm}$ Perimeter = $(15 \times 2) + (11 \times 2) + (5 \times 2) + (3 \times 2) + (5 \times 2) = 78\text{cm}$
Q11	Total playing time = $5\text{h} = 300\text{min}$ $300\text{min} - 30\text{min} = 270\text{min}$ $270 \div 3 = 90\text{min}$ A : B : C $120 : 90 : 90$ $4 : 3 : 3$

Q12a	$(1.42 + 1.43 + 1.37 + 1.26) \div 4 = \mathbf{1.37\ m}$
Q12b	$1.34 \times 5 = 6.7\ \text{m}$ $6.7 - 5.48 = \mathbf{1.22\ m}$
Q13	$1\ \text{h}\ 40\ \text{min} + 15\ \text{min} = 1\ \text{h}\ 55\ \text{min} = 115\ \text{min}$ Duration of time from 9 am to 6.20 pm = 9 h 20 min = 560 min $560 \div 115 = 4\ \text{R}\ 100\ \text{min}$ $100\ \text{min} = 1\ \text{h}\ 40\ \text{min} \rightarrow$ enough to make 1 more shirt but no break after Ans: 5 shirts
Q14a	Vol. of tank = $30\ \text{cm} \times 12\ \text{cm} \times 18\ \text{cm} = 6480\ \text{ml}$ Vol. of water = $6480 \div 3 = 2160\ \text{ml} = \mathbf{2\frac{4}{25}\ \ell}$
Q14b	Vol. of half tank = $6480 \div 2 = 3240\ \text{ml}$ Vol. of water needed = $3240 - 2160 = 1080\ \text{ml} = \mathbf{1\ \ell\ 80\ \text{ml}}$
Q15	Area of big square = $4\ \text{cm} \times 4\ \text{cm} = 16\ \text{cm}^2$ Shaded area = $2(1 \times 3) = 6\ \text{cm}^2$ Unshaded area = $16 - 6 = \mathbf{10\ \text{cm}^2}$
Q16a	Grey = 9 , total = 15
Q16b	Total white beads for Fig 21 = $2 + 4 + 6 + 8 + 10 + 12 + 14 + 16 + 18 + 20$ = 110
Q16c	True, True
Q17	$6u = \$480$ $1u = \$80$ $13u = \$80 \times 13 = \mathbf{\$1040}$

