

Name: \_\_\_\_\_ ( )

Class: Primary 5 \_\_\_\_\_

CHIJ ST NICHOLAS GIRLS' SCHOOL (PRIMARY)



Primary 5 Mathematics

End - Year Assessment

Paper 1

Booklet A

15 questions

20 marks

Total Time for Booklets A and B: 1 hour

**INSTRUCTIONS TO CANDIDATES**

Do not turn over this page until you are told to do so.

Follow all instructions carefully.

Answer all questions.

Write your answers in this booklet.

The use of calculators is **NOT** allowed.

This booklet consists of 10 printed pages.

Questions 1 to 10 carry 1 mark each. Questions 11 to 15 carry 2 marks each. For each question, four options are given. One of them is the correct answer. Make your choice (1, 2, 3 or 4). Shade the correct oval (1, 2, 3, or 4) on the Optical Answer Sheet.

(20 marks)

---

1. In which one of the following numbers does the digit 5 have a value of 50 000?

(1) 1 243 506

(2) 3 705 291

(3) 4 658 120

(4) 6 582 437

2. Which one of the following fractions is smaller than  $\frac{1}{4}$ ?

(1)  $\frac{5}{6}$

(2)  $\frac{3}{8}$

(3)  $\frac{2}{5}$

(4)  $\frac{1}{6}$

3.  $16 + \frac{\boxed{?}}{10} = 17.8$

What is the missing number in the box?

- (1) 0.8
- (2) 1.8
- (3) 18
- (4) 180

4. In the number line below, what is the value of X?

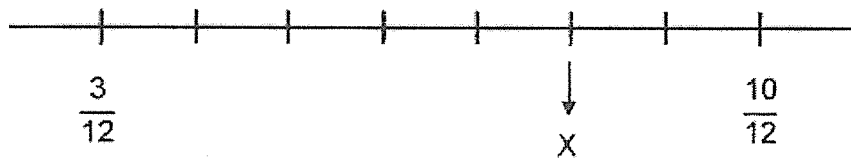

- (1)  $\frac{1}{2}$
- (2)  $\frac{2}{3}$
- (3)  $\frac{3}{4}$
- (4)  $\frac{7}{12}$

5. Yu Wen had \$7000 in her bank account. The bank paid 2% interest at the end of each year. She did not withdraw any of her savings. How much interest did she earn at the end of 1 year?

(1) \$140

(2) \$350

(3) \$6860

(4) \$7140

6. There are 10 chickens at a farm. There are 35 more ducks than chickens. What is the ratio of the number of ducks to the number of chickens?

(1) 2 : 7

(2) 2 : 9

(3) 7 : 2

(4) 9 : 2

Lovely Flower Shop sold a total of 80 flowers on Monday. The table below shows the number of different types of flowers sold on that day. The number of tulips sold is not known.

*Refer to the table below to answer questions 7 and 8.*

Type of flowers sold	Number of flowers sold
Daisies	20
Lilies	15
Roses	25
Tulips	?

7. What is the total number of tulips and daisies sold on Monday?

- (1) 20
- (2) 40
- (3) 60
- (4) 80

8. Which one of the following graphs represents the information shown in the table correctly?

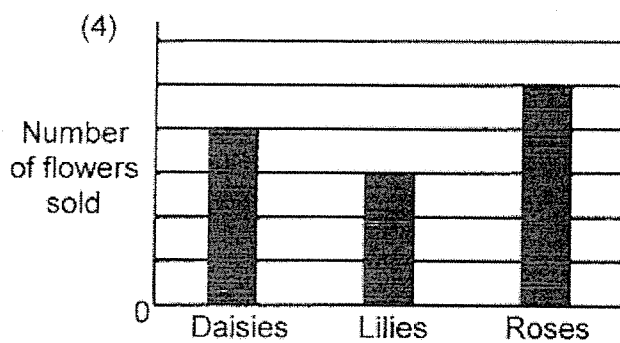
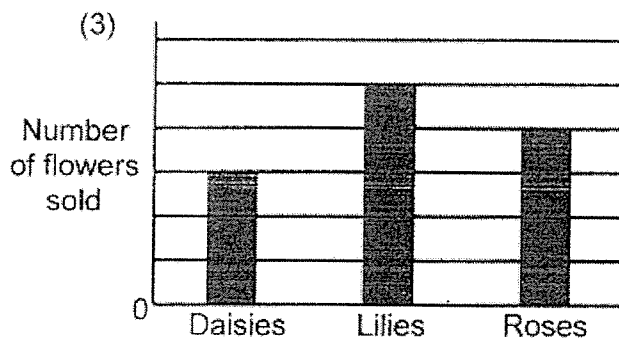
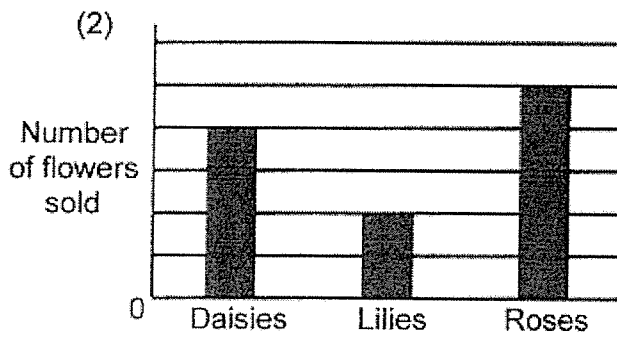
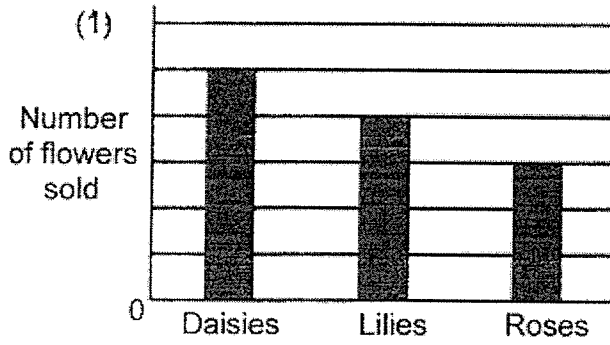

9. Harumi had a piece of string 4 m 6 cm. She cut off 1.3 m from it. What is the length of the remaining string?

- (1) 276 cm
- (2) 330 cm
- (3) 393 cm
- (4) 447 cm

10. In the figure shown below, AB and CD are straight lines. Which one of the following statements is true?

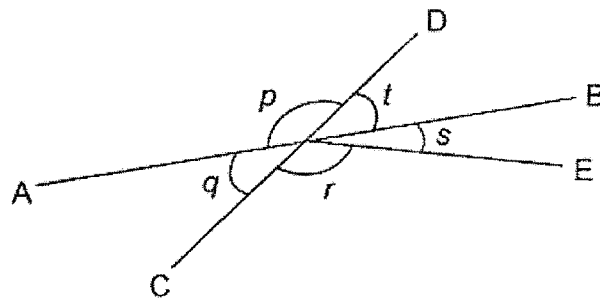

- (1)  $\angle p = \angle r$
- (2)  $\angle q = \angle t$
- (3)  $\angle p = \angle q + \angle r$
- (4)  $\angle q = \angle t + \angle s$

11. A sandwich costs \$6.05. Leonard bought 4 such sandwiches and had \$1.85 left. How much money did he have before buying the 4 sandwiches?

- (1) \$4.20
- (2) \$7.90
- (3) \$22.35
- (4) \$26.05

12. Amiya and Eunice have \$2100 altogether. Amiya has 30% of the money. How much money does Amiya have?

- (1) \$21
- (2) \$70
- (3) \$300
- (4) \$630



13. A store charges the following rates for the order of T-shirts.

First 15 pieces	\$6 per piece
For every additional piece	\$4 per piece

What is the cost of ordering 50 pieces of T-shirts?

- (1) \$200
- (2) \$230
- (3) \$270
- (4) \$300

14. Mrs Urvi cut a cake into 16 equal pieces. She ate 3 pieces and gave a few pieces to her friends. In the end, she had  $\frac{3}{8}$  of the cake left. What fraction of the cake did she give to her friends?

- (1)  $\frac{3}{16}$
- (2)  $\frac{5}{8}$
- (3)  $\frac{7}{16}$
- (4)  $\frac{9}{16}$

15. Jamil used some shapes to form a pattern. The first 9 shapes are shown below. Which shape is in the 52<sup>nd</sup> position?

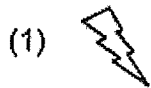
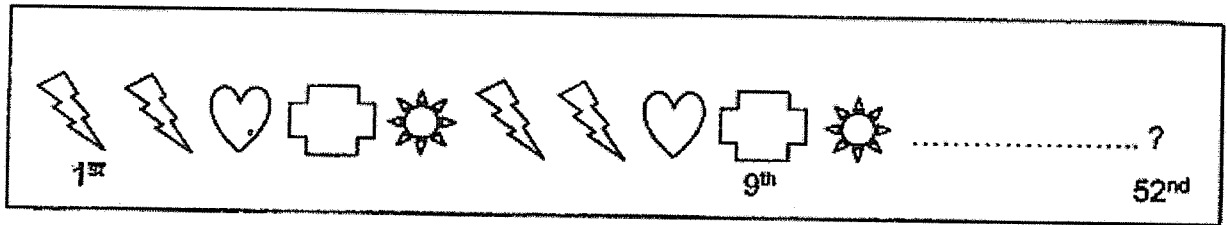

**\*\*End of Booklet A\*\***

Name: \_\_\_\_\_ ( )

Class: Primary 5 \_\_\_\_\_

CHIJ ST NICHOLAS GIRLS' SCHOOL (PRIMARY)

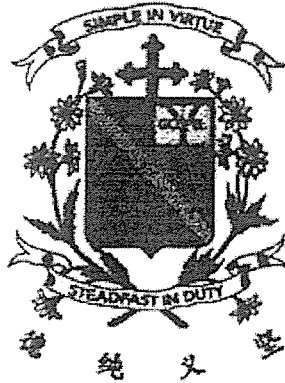

Primary 5 Mathematics

End - Year Examination

Paper 1

Booklet B

Booklet A	20
Booklet B	25
Total (Paper 1)	45

Total Time for Booklets A and B: 1 hour

**INSTRUCTIONS TO CANDIDATES**

Do not turn over this page until you are told to do so.

Follow all instructions carefully.

Answer all questions.

Write your answers in this booklet.

The use of calculators is **NOT** allowed.

This booklet consists of 9 printed pages.

Questions 16 to 20 carry 1 mark each. Show your working clearly and write your answers in the spaces provided. For questions which require units, give your answers in the units stated. (5 marks)

Do not write in this space

16. Find the value of  $57 \div 300$ . Leave your answer as a decimal.

Ans : \_\_\_\_\_

17. Find the value of  $11 + (18 - 14 \div 2) \times 3$ .

Ans : \_\_\_\_\_

18. What is six-fifths of 60?

Ans : \_\_\_\_\_

19. Mrs Cheah bought an iron which included a GST of 7%. The price of the iron before GST was \$90. How much did she pay for the iron?

Do not  
write in  
this space

Ans : \$ \_\_\_\_\_

20. A photocopier can copy 48 pages in 4 minutes. At this rate, how many pages can the photocopier copy per minute?

Ans : \_\_\_\_\_

--

Questions 21 to 30 carry 2 marks each. Show your working clearly and write your answers in the spaces provided. For questions which require units, give your answers in the units stated. (20 marks)

Do not write in this space

21. Arrange the following from the smallest to the largest.

$0.209$ , $\frac{1}{5}$ , $\frac{2}{1000}$
--

Ans : \_\_\_\_\_

22. Last year, Bertrand completed a race in 51.98 seconds. This year, he completed the same race and was faster by 1.31 seconds. What was Bertrand's timing this year? Round your answer to 1 decimal place.

Ans : \_\_\_\_\_ s

--

23. In the figure below, find  $\angle z$ .

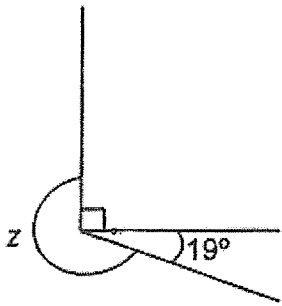

Ans : \_\_\_\_\_°

24. Refer to the square grid below. Caden was standing at one of the points, facing point B. After making a  $\frac{3}{4}$  - turn anticlockwise, he was facing point F. At which point was he standing?

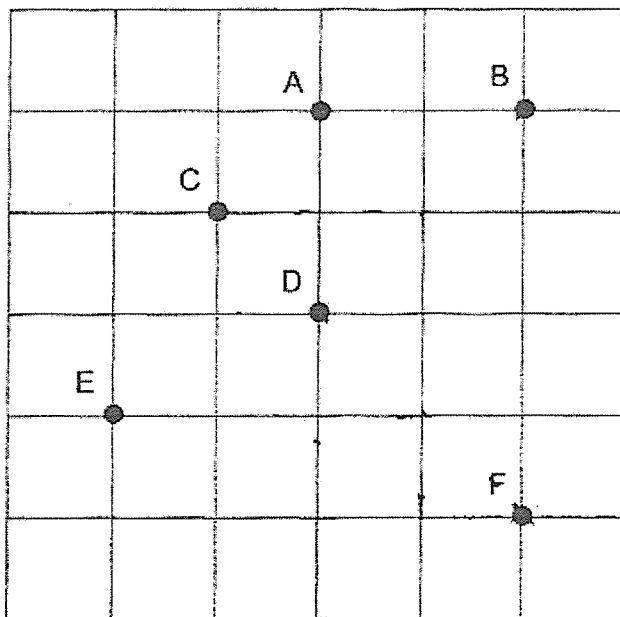

Ans : \_\_\_\_\_

Do not  
write in  
this space

25. The height of a cuboid is 20 m. Its height is twice its length. Its breadth is 6 m shorter than its length. Find the volume of the cuboid.

Do not  
write in  
this space

Ans : \_\_\_\_\_ m<sup>3</sup>

26. At first, a pot contained  $\frac{2}{5}$  ℓ of water. Keisha added another  $\frac{1}{2}$  ℓ of water into the pot. Then she used  $\frac{2}{9}$  of all the water in the pot. How much water did Keisha use? Express your answer as a fraction in its simplest form.

Ans : \_\_\_\_\_ ℓ

--



27. The bar graph below shows the number of pupils who donated to charity over 4 days. The bar representing Day 4 has not been drawn.

Do not write in this space

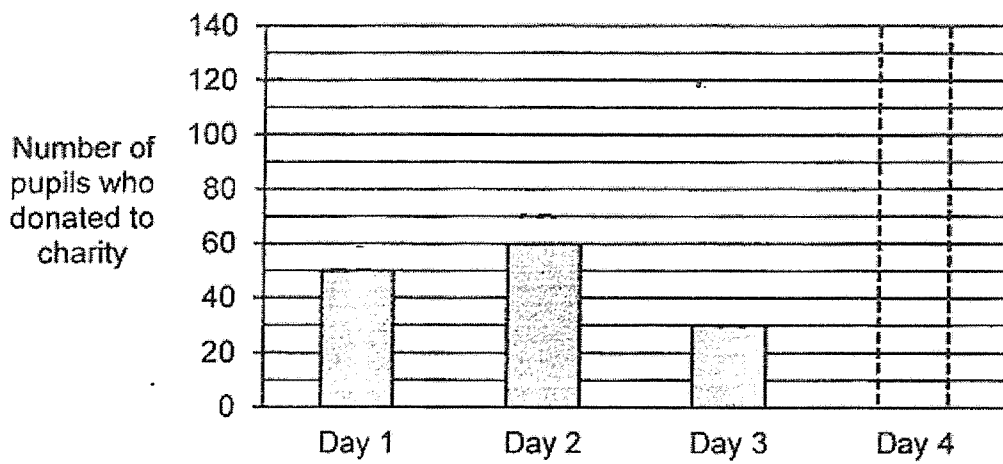

Over the 4 days, all the pupils donated a total amount of \$460. Each pupil donated \$2. How many pupils donated on Day 4?

Ans : \_\_\_\_\_

28. The ratio of Jim's age to Frank's age is 1 : 6. In 5 years' time, they would be 73 years old altogether. What is Jim's age now?

Do not  
write in  
this space

Ans : \_\_\_\_\_

29. Two different whole numbers add up to 140. One of them is a 2-digit number and the other is a 3-digit number. What are the two numbers that will give the greatest possible difference?

Ans : \_\_\_\_\_ and \_\_\_\_\_

30. There were 80 more men than women at a concert. The number of men was  $\frac{5}{8}$  of the total number of adults. There was an equal number of boys and girls at the concert.

Do not  
write in  
this space

Each statement below is either true, false or not possible to tell from the information given. For each statement, put a tick (✓) in the correct column.

Statement	True	False	Not Possible to Tell
There were 120 women at the concert.			
There were more females than males at the concert.			

**\*\*End of Booklet B\*\***

--



Name: \_\_\_\_\_ ( )

Class: Primary 5 \_\_\_\_\_

**CHIJ ST NICHOLAS GIRLS' SCHOOL (PRIMARY)**

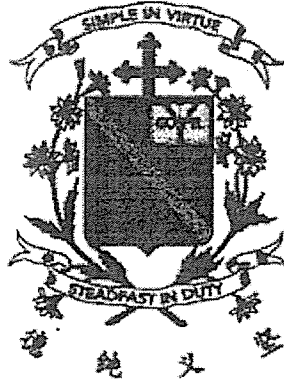

**Primary 5 Mathematics**

**End - Year Assessment**

**Paper 2**

Paper 1	45
Paper 2	55
Total Marks	100

**Time : 1 hour 30 minutes**

**INSTRUCTIONS TO CANDIDATES**

Do not turn over this page until you are told to do so.

Follow all instructions carefully.

Answer all questions.

Write your answers in this booklet

The use of an approved calculator is expected, where appropriate.

This booklet consists of 16 printed pages.

Questions 1 to 5 carry 2 marks each. Show your working clearly and write your answers in the spaces provided. For questions which require units, give your answers in the units stated. (10 marks)

Do not write in this space

1. When a number is divided by 3, the answer is 6041. What is the answer obtained when the same number is divided by 7?

Ans : \_\_\_\_\_

2. There were 1780 people at a carnival. 45% of them were adults and the rest were children. How many children were at the carnival?

Ans : \_\_\_\_\_

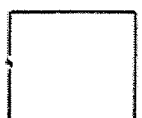

3. Find the area of triangle ABC.

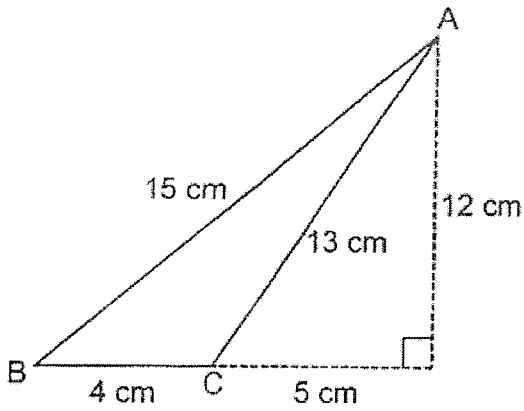

Ans : \_\_\_\_\_ cm<sup>2</sup>

4. In the square grid below, draw a right-angled triangle PQR where PQ = 6 units. Line QR has been drawn for you. Label PQR clearly.

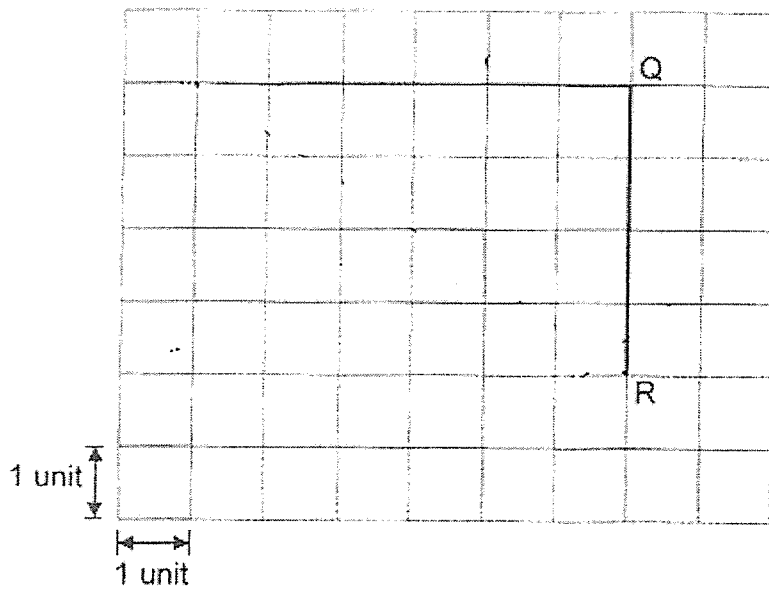

Do not  
write  
in this  
space



5. Meri is given a card with 3 numbers circled. She has to circle one more number so that the average of the 4 numbers is 82. Write down the number that Meri should circle.

Do not write in this space

88	81	84
83	86	80
89	75	79

Ans : \_\_\_\_\_

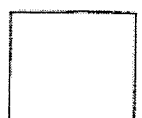



For questions 6 to 17, show your working clearly and write your answers in the spaces provided. The number of marks available is shown in the brackets ( ) at the end of each question or part-question. (45 marks)

Do not write in this space

6. Some identical lightbulbs were hung on a rod 91 cm long. The first and the last lightbulb were hung 14 cm away from each end of the rod. The rest of the lightbulbs were hung at an equal distance of 9 cm apart. How many lightbulbs were hung on the rod altogether?

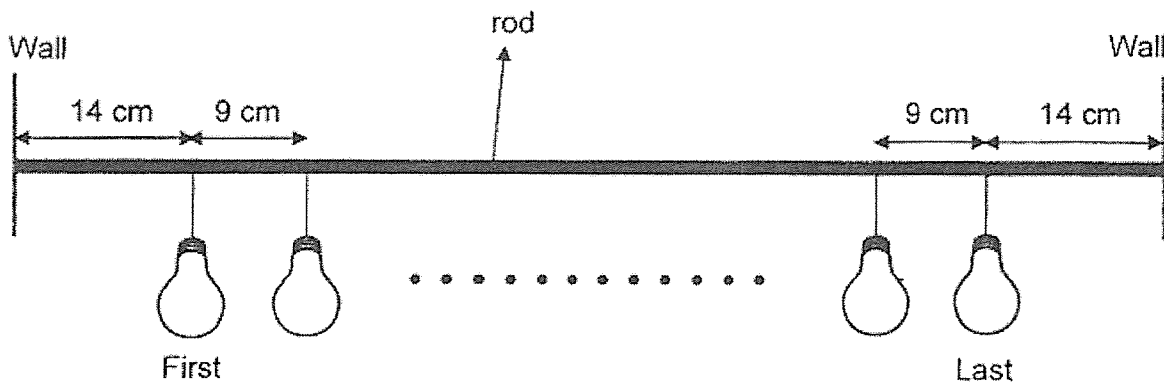

Ans : \_\_\_\_\_ [3]

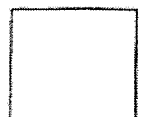

7. Cecily and Nadine shared the total cost of a handbag. Cecily paid \$39 more than  $\frac{4}{9}$  of the total cost of the handbag. Nadine paid \$186. How much did the handbag cost?

Do not  
write  
in this  
space

Ans : \_\_\_\_\_ [3]

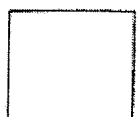

8. The table below shows the charges for renting a bicycle.

Do not  
write  
in this  
space

Days	Time	Charge
Mon to Fri	9 a.m. to 8 p.m.	\$11 per hour
Sat and Sun	8 a.m. to 4 p.m.	\$14 per hour
	4 p.m. to 7 p.m.	\$15 per hour

- (a) Lei Xin rented a bicycle from 9 a.m. to 12 noon on Thursday. How much did she pay?
- (b) On Sunday, Deric rented a bicycle and returned it at 5 p.m. He paid a total amount of \$71. <sup>How</sup> For many hours did he rent the bicycle?

Ans : (a) \_\_\_\_\_ [1]

(b) \_\_\_\_\_ [2]



9. Winsy had some purple beads and an equal number of red beads and yellow beads. The ratio of the number of purple beads to the number of red beads was 5 : 7. Winsy had 210 more red beads than purple beads. How many red beads and yellow beads did she have altogether?

Do not  
write  
in this  
space

Ans : \_\_\_\_\_ [3]

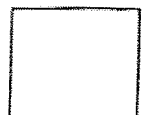

10. The rectangle below is made up of some triangles. The three unshaded triangles are identical. The perimeter of the rectangle is 84 cm. Its breadth is 15 cm. Find the total area of the shaded triangles.

Do not write in this space

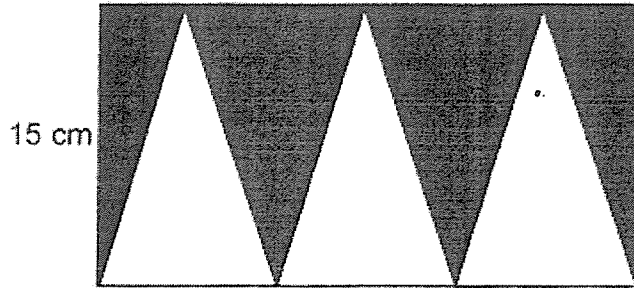

Ans : \_\_\_\_\_ [3]

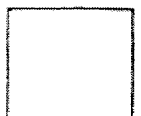

11. In the figure below, ABC and ACD are triangles.  $\angle BAC = 36^\circ$  and  $\angle BCD = 110^\circ$ .  
AC = AD. Find  $\angle ABC$ .

Do not write in this space

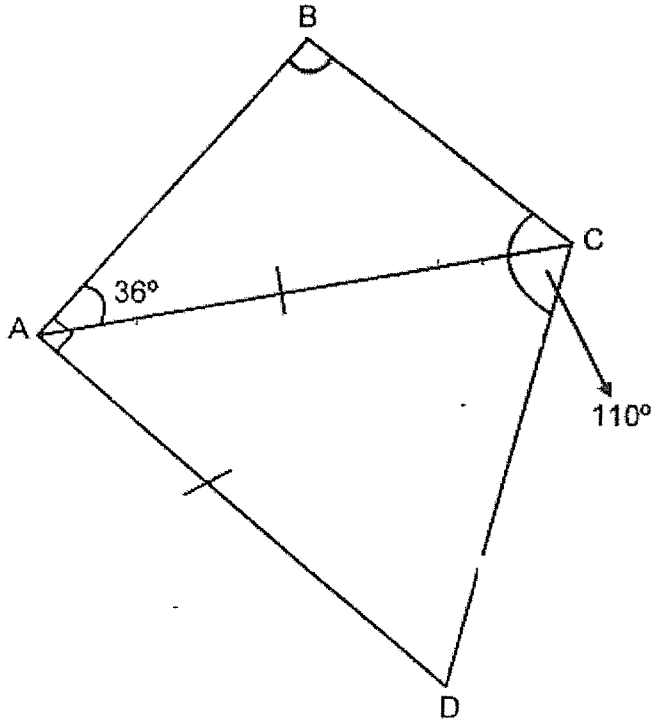

Ans : \_\_\_\_\_ [3]



12. At Doughnut Empire, each doughnut is sold at \$1.10 or in a box of 11 for \$8.90. Mrs Kor wants to buy exactly 208 doughnuts. What is the least amount of money that she needs to pay for the doughnuts?

Do not  
write  
in this  
space

Ans : \_\_\_\_\_ [4]



13. Vinette had some white and black face masks.  $\frac{1}{6}$  of them were white. She gave away  $\frac{1}{3}$  of the white face masks and  $\frac{1}{3}$  of the black face masks. In the end, she had 156 white and black face masks altogether. How many black face masks did Vinette have at first?

Do not  
write  
in this  
space

Ans : \_\_\_\_\_ [4]

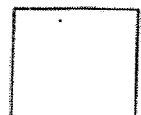



14. The graph below shows the number of air purifiers sold by Mr Seng from January to May.

Do not write in this space

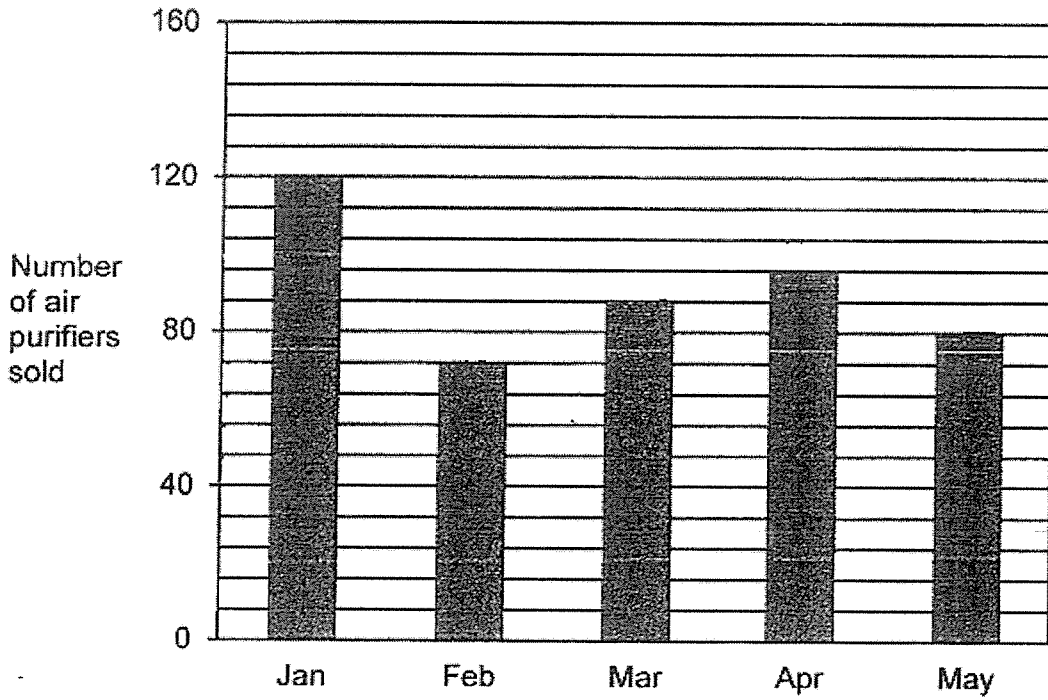

- (a) Write down all the months in which Mr Seng sold at least 88 air purifiers.
- (b) Mr Seng sold 40 more air purifiers in June than in May. Find the average number of air purifiers sold from March to June.

Ans : (a) \_\_\_\_\_ [1]

(b) \_\_\_\_\_ [3]

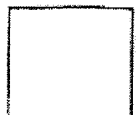

15. Tank Q is a cubical container of edge 30 cm. It is completely filled with water.  
 Tank R is a rectangular tank measuring 56 cm by 31 cm by 18 cm. It is filled with water flowing from a tap at a rate of 0.6 l per minute. 6 minutes later, the tap is turned off.

Do not write in this space

- (a) Find the volume of water in Tank R after 6 minutes.
- (b) All the water in Tank Q is then poured into Tank R without spilling.  
 How much more water is needed to fill Tank R completely?  
 Give your answer in litres.

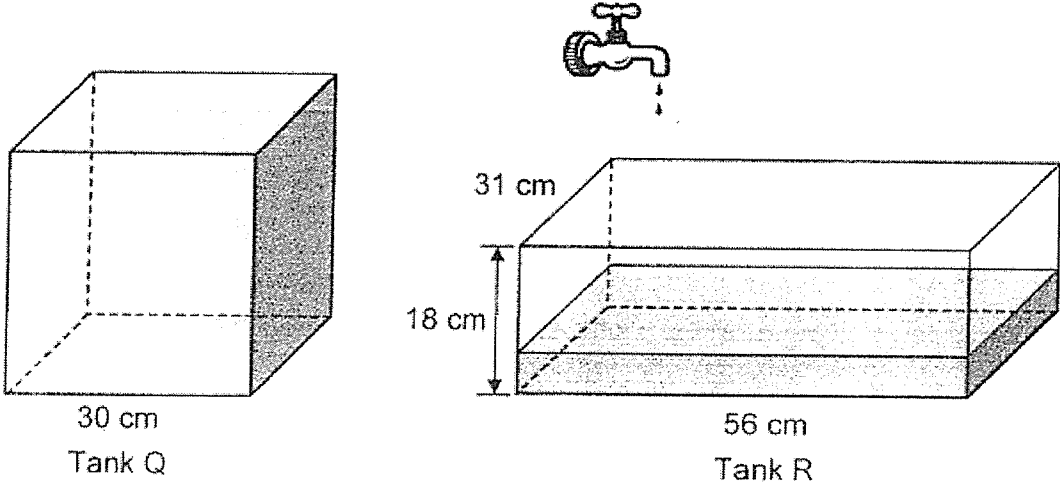

Ans : (a) \_\_\_\_\_ [1]

(b) \_\_\_\_\_ [4]



16. The figure below shows two identical equilateral triangles JEF and JHK.  
 $\angle FJH = 88^\circ$ . EGH is a straight line.

Do not write in this space

- (a) Name an acute-angled triangle in the figure. *all  $\angle$ s in  $\Delta$  must be less than  $90^\circ$*   
 (b) Find  $\angle EJK$ .  
 (c) Find  $\angle FGE$ .

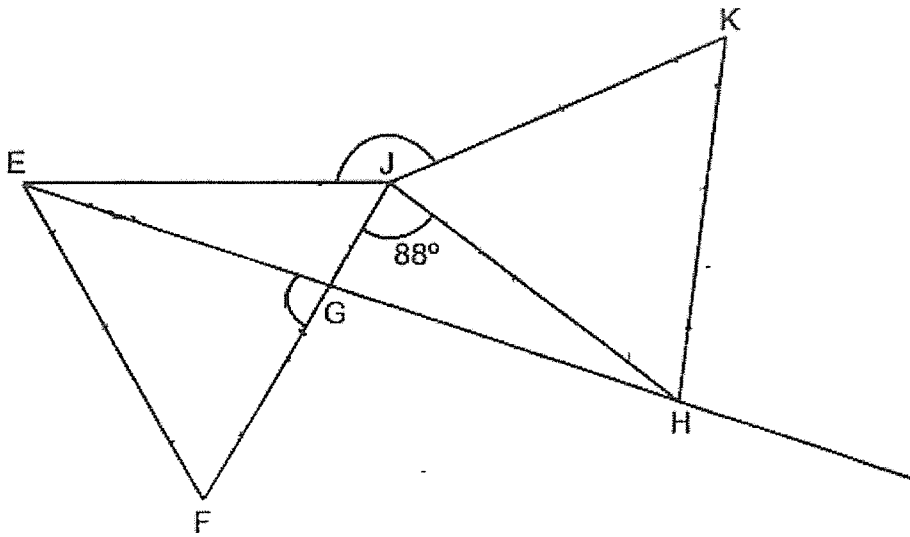

Ans : (a) Triangle \_\_\_\_\_ [1]

(b) \_\_\_\_\_ [2]

(c) \_\_\_\_\_ [2]



17. Rei and Ning drew lines to form triangles and stars.

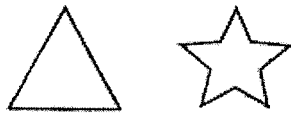

Do not  
write  
in this  
space

(a) Rei formed a total of 10 triangles and stars. She drew 48 more lines for the stars than for the triangles. How many stars did she form?

(b) Ning drew 14 more triangles than stars. The number of lines drawn for the triangles was the same as the number of lines drawn for the stars. The total number of lines drawn was more than 30 but less than 180. What fraction of the shapes that Ning had drawn were stars?

Ans : (a) \_\_\_\_\_ [2]

(b) \_\_\_\_\_ [3]

\*End of Paper\*



SCHOOL : CHIJ ST NICHOLAS GIRLS' PRIMARY SCHOOL  
 LEVEL : PRIMARY 5  
 SUBJECT : MATH  
 TERM : END – YEAR ASSESSMENT

PAPER 1 BOOKLET A

Q 1	Q2	Q3	Q4	Q5	Q6	Q7	Q8	Q9	Q10
3	4	3	2	1	4	2	4	1	2

Q 11	Q12	Q13	Q14	Q15
4	4	2	3	1

PAPER 1 BOOKLET B

Q16)	0.19
Q17)	44
Q18)	72
Q19)	\$96.30
Q20)	12
Q21)	0.209 $\frac{1}{5} = 0.200$ $\frac{2}{1000} = 0.002$ Ans: $\frac{2}{1000}, \frac{1}{5}, 0.209$
Q22)	$51.98 - 1.31 = 50.67$ $\approx 50.7$ Ans: 50.7s
Q23)	$360 - 90 - 19 = 251$ Ans: $251^\circ$
Q24)	D
Q25)	$20 \div 2 = 10$ $10 - 6 = 4$ $20 \times 10 \times 4 = 800$
Q26)	$\frac{2}{5} = \frac{4}{10}$ $\frac{1}{2} = \frac{5}{10}$

	$\frac{4}{10} + \frac{5}{10} = \frac{9}{10}$ $\frac{9}{10} \times \frac{2}{9} = \frac{2}{10}$ $\frac{2}{10} = \frac{1}{5}$ <p>Ans <math>\frac{1}{5}</math> ℓ</p>			
Q27)	$50 + 60 + 30 = 140$ $140 \times 2 = 280$ $460 - 280 = 180$ $180 \div 2 = 90$ <p>Ans: 90 pupils</p>			
Q28)	$73 - 10 = 63$ $63 \div 7 = 9$ <p>Ans: 9 years old</p>			
Q29)	$10 + 130 = 140$ $130 - 10 = 120$ <p>Ans: 10 and 130</p>			
Q30)	Statement	True	False	Not possible to tell
	There were 120 women at the concert.	√		
	There were more females than males at the concert.		√	
	$5 - 3 = 2$ $80 \div 2 = 40$ $40 \times 3 = 120$ $40 \times 5 = 200$			

**PAPER 2**

Q1)	$6041 \times 3 = 18123$ $18123 \div 7 = 2589$ <p>Ans: 2589</p>
Q2)	$100 - 45 = 55$ $1780 \div 100 = 17.8$ $17.8 \times 55 = 979$ <p>Ans: 979 children</p>
Q3)	$\frac{1}{2} \times 4 \times 12 = 24$ <p>Ans: 24 cm<sup>3</sup></p>

Q4)	
Q5)	$82 \times 4 = 328$ $88 + 86 + 79 = 253$ $328 - 253 = 75$ <b>Ans: 75</b>
Q6)	$91 - 14 - 14 = 63$ $63 \div 9 = 7$ $7 + 1 = 8$ <b>Ans: 8 bulbs</b>
Q7)	$186 + 39 = 225$ $1 - \frac{4}{9} = \frac{5}{9}$ $225 \div 5 = 45$ $45 \times 9 = 405$ <b>Ans: \$ 4065</b>
Q8)	a) $11 \times 3 = 33$ <b>Ans: \$33</b> b) $71 - 15 = 56$ $56 \div 14 = 4$ $4 + 1 = 5$ <b>Ans: 5 hours</b>
Q9)	$7 + 7 = 14$ $7 - 5 = 2$ $210 \div 2 = 105$ $105 \times 14 = 1470$ <b>Ans: 1470 beads</b>
Q10)	$15 \times 2 = 30$ $84 - 30 = 54$ $54 \div 2 = 27$ $27 \div 3 = 9$ $\frac{1}{2} \times 9 \times 15 = 67.5$ $67.5 \times 3 = 202.5$ $15 \times 27 = 405$ $405 - 202.5 = 202.5$ <b>Ans: 202.5 cm<sup>2</sup></b>
Q11)	$90 - 36 = 54$

	$180 - 54 = 126$ $126 \div 2 = 63$ $110 - 63 = 47$ $180 - 36 - 47 = 97$ <b>Ans: <math>97^\circ</math></b>
Q12)	$208 \div 11 \approx 18.9$ $18 \times 8.90 = 160.2$ $10 \times 1.10 = 11$ $160.2 + 11 = 171.20$ <b>Ans: \$171.20</b>
Q13)	$1 + 5 = 6$ $18 - 6 = 12$ $156 \div 12 = 13$ $13 \times 15 = 195$ <b>Ans: 195 face masks</b>
Q14)	a) <b>Ans: Jan, Mar, Apr</b> b) $80 + 40 = 120$ $120 + 88 + 96 + 80 = 384$ $384 \div 4 = 96$ <b>Ans: 96 air purifiers</b>
Q15)	a) $0.6 \times 6 = 3.6$ <b>Ans: 3.6 ℓ</b> b) $56 \times 18 \times 31 = 31248$ $30 \times 30 \times 30 = 27000$ $27000 \text{cm}^3 = 27 \ell$ $3.6 + 27 = 30.6$ $56 \times 31 \times 18 = 31248$ $3124 \text{ cm}^3 = 31.248 \ell$ $31.248 - 30.6 = 0.648$ <b>Ans: 0.648 ℓ</b>
Q16)	a) Triangle JGH b) $360 - 60 - 88 - 60 = 152$ <b>Ans: <math>152^\circ</math></b> c) $180 - 88 = 92$ $180 - 60 = 120$ $120 - 92 = 28$ $60 + 88 = 148$ $180 - 148 = 32$ $32 \div 2 = 16$ $60 - 16 = 44$ $180 - 60 - 44 = 76$ <b>Ans: <math>76^\circ</math></b>
Q17)	a) $10 - 3 = 7$ $14 \times 3 = 42$ $42 \div 7 = 6$ <b>Ans: 6 stars</b> b) $6 + 14 = 20$ $20 + 6 = 26$



	$\frac{6}{26} = \frac{3}{13}$ Ans: $\frac{3}{13}$
--	--

